

iGAGING®

METROLOGY
MASTER CATALOG 2022



ENJOY ACCURACY®

iGAGING **DATACONNECT DATA OUTPUT KITS**

iGAGING DataConnect output kits provide reliable solutions for data collection. All kits will work with iGAGING products that has SPC data port built in. These kits will function as a keyboard and input collected data to an compatible electronic device and with compatible software.



100-USB-FT

*Additional equipment not included



Item #	Description
100-700-USB	DataConnect Cable Kit (SPC output to USB cable plug in)
100-700-USB-MC	Micro DataConnect Cable Kit (SPC output to Mirco USB cable plug in)
100-USB-FT	Plug in Foot Switch for #100-700-USB



35-WL-CAD

*Additional equipment not included



WIRELESS DATACONNECT KIT - 15 METER RANGE

Item #	Description
35-WL-CAD	Wireless DataConnect Kit (SPC output to USB flash drive receiver)
35-WL-MC	Micro Wireless DataConnect Cable Kit (SPC output to Mirco USB cable plug in)

Battery CR2032 included

*Additional equipment not included

SMART WIRELESS DATACONNECT KIT - 5 METER RANGE



35-BT-28

Item #	Description
35-BT-28	Smart Wireless DataConnect Kit (SPC output to Bluetooth enabled device)
35-BT-MC	Smart Wireless Micro DataConnect Cable Kit (Mirco USB output cable plug in)

Battery CR2032 included



ISO 17025 Calibration Certificate is available as optional service product for some of iGAGING gauges and tools.

IP54 ORIGINAL CAL ABSOLUTE DIGITAL CALIPERS



100-700-06

iGAGING[®]
EXCLUSIVE

ORIGIN ABSOLUTE
SERIES



100-700-08

PATENTED

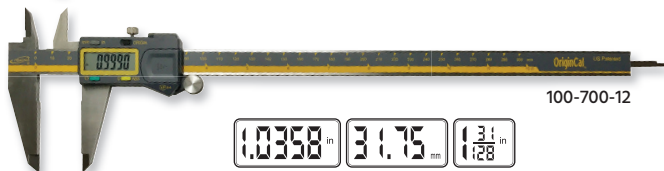

100-700-12



SPC
Data Output

- IP54 protective rating:
Moisture and dust resistance
- Absolute encoding technology
Memorize absolute origin zero
- Ultra-Response measure speed
- Inch/Metric conversion
- Resolution: 0.0005"/0.01 mm
- High contrast LCD display
- Stainless steel frame
- SPC/USB data output
- Battery 3V CR2032 included
- Supplied in protective case

Item #	Range	Accuracy
100-700-04	0 - 4"/100 mm	0.001"/0.02 mm
100-700-06	0 - 6"/150 mm	0.001"/ 0.02 mm
100-700-33*	0 - 6"/150mm/ 1/128"	0.001"/ 0.02 mm
100-700-08	0 - 8"/200 mm	0.0015"/ 0.03 mm
100-700-12	0 - 12"/300 mm	0.0015"/ 0.03 mm

*Fractional

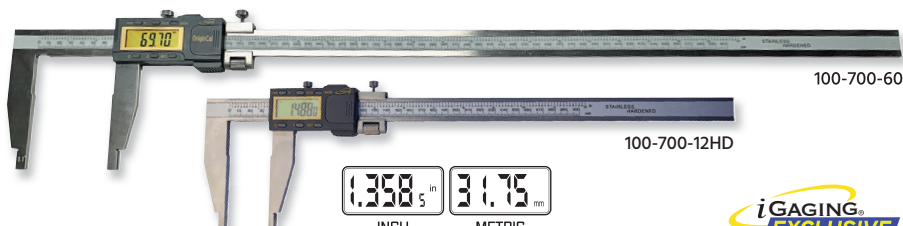

100-700-60



100-700-12HD

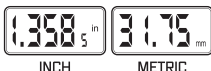

iGAGING[®]
EXCLUSIVE

ORIGIN ABSOLUTE
SERIES

IP54 ORIGINAL CAL ABSOLUTE HEAVY DUTY DIGITAL CALIPERS



- IP54 protective rating:
Moisture and dust resistance
- Absolute encoding technology
Memorize absolute origin zero
- Ultra-Response measure speed
- Inch/Metric conversion
- Resolution: 0.0005"/0.01 mm
- High contrast LCD display
- Fine adjustment screw

- Heavy duty stainless steel frame
- SPC/UBS data output
- Battery 3V CR2032 included
- Supplied in protective case

SPC
Data Output

Item #	Range	Accuracy
100-700-12HD	0 - 12"/300 mm	0.003"/0.08 mm
100-700-60	0 - 24"/600 mm	0.003"/0.08 mm
100-700-90	0 - 40"/1000 mm	0.004"/ 0.10 mm

iGAGING[®]
EXCLUSIVE

ORIGIN ABSOLUTE
SERIES

IP54



100-700-26



100-700-34

SPC 
Data Output



100-700-28



INCH

METRIC



100-700-35

IP54 ORIGINCAL ABSOLUTE DIGITAL DEPTH CALIPERS

- IP54 protective rating: Moisture and dust resistance
- Absolute encoding technology
Memorize absolute origin zero
- Ultra-Response measure speed
- Inch/Metric conversion
- Resolution: 0.0005"/0.01 mm
- High contrast LCD display
- Stainless steel frame
- SPC/USB data output
- Battery 3V CR2032 included
- Supplied in protective case

Item #	Range	Description	Accuracy
100-700-26	0 - 6"/150 mm	Single Hook Depth Caliper	0.001"/0.02 mm
100-700-28	0 - 6"/150 mm	Double Hook Depth Caliper	0.001"/0.02 mm
100-700-D08	0 - 8"/200 mm	Double Hook Depth Caliper	0.0015"/0.03 mm
100-700-D12	0 - 12"/300 mm	Double Hook Depth Caliper	0.0015"/0.03 mm
100-700-34	0 - 6"/150 mm	Single Cut Depth Caliper	0.001"/0.02 mm
100-700-35	0 - 6"/150 mm	Interchangeable Anvil Depth	0.001"/0.02 mm
100-700-USB	SPC/USB Cable Data Kit		
35-WL-USB	Wireless Dongle Data Kit (Dongle to USB Flash Drive)		
35-BT-28	BT Wireless Dongle Data Kit (Dongle to Device)		



100-700-36

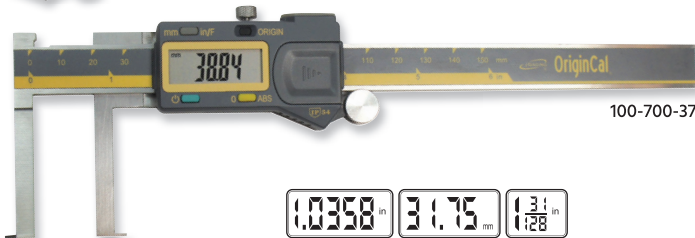

100-700-37

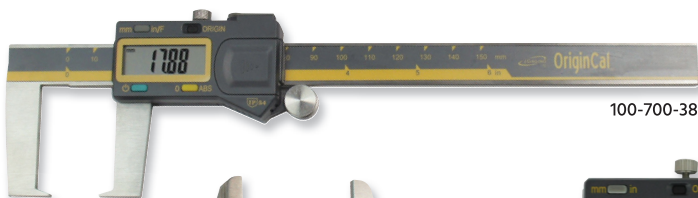

100-700-38



100-700-39



Caliper sold separately

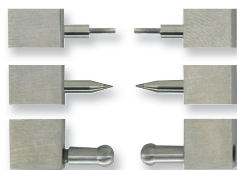

100-700-43
Interchangeable Anvils



IP54 ORIGINCAL ABSOLUTE INSIDE & OUTSIDE DIGITAL CALIPERS

- IP54 protective rating:
Moisture and dust resistance
- Absolute encoding technology
Memorize absolute origin zero
- Ultra-Response measure speed
- Resolution: 0.0005"/0.01 mm
- Accuracy: 0.001"/0.02 mm
- Inch/Metric conversion
- High contrast LCD display
- Stainless steel frame
- SPC/USB data output
- Battery 3V CR2032 included
- Supplied in protective case
- Data Kits on page 2 will work on all calipers listed

Item #	Range	Description
100-700-36	0 - 6"/150 mm	Tube Thickness Measuring Caliper
100-700-37	0.79 - 6"/20 - 150 mm	Internal Thickness Measuring
100-700-38	0 - 6"/150mm	Outside Slot Measuring Caliper
100-700-39*	0 - 1.45"/37 mm/ 1/128"	Snap Thickness Caliper
100-700-43	0 - 6"/150 mm	Interchangeable Anvils for Calipers

*Inch Fraction

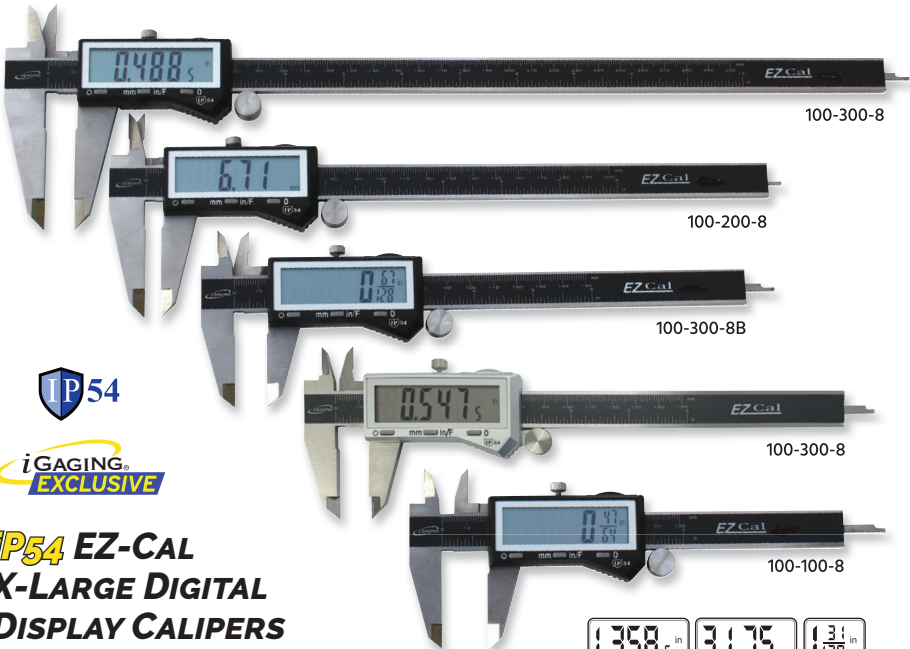

100-300-8

100-200-8

100-300-8B

100-300-8

100-100-8



INCH METRIC FRACTION



iGAGING EXCLUSIVE

IP54 EZ-CAL X-LARGE DIGITAL DISPLAY CALIPERS

- IP54 protective rating: Moisture and dust resistance
- Easy view X-Large LCD display
- Ultra-Response measure speed
- Resolution: 0.0005"/0.01 mm/ 1/128"
- Stainless steel frame
- Battery 3V CR2032 included
- Supplied in protective case

Item #	Range	Display Color	Accuracy
100-100-8S	0 - 4"/100 mm	Silver	0.001"/0.02 mm
100-100-8	0 - 4"/100 mm	Black	0.001"/0.02 mm
100-333-8	0 - 6"/150 mm	Silver	0.001"/0.02 mm
100-333-8B	0 - 6"/150 mm	Black	0.001"/0.02 mm
100-200-8	0 - 8"/200 mm	Black	0.0015"/0.03 mm
100-300-8	0 - 12"/300 mm	Black	0.0015"/0.03 mm

iGAGING EXCLUSIVE



100-777



INCH METRIC FRACTION

IP54 DIGITAL WELDING GAUGE

- IP54 protective rating: Moisture and dust resistance
- Range: 0 - 1.25"/32 mm
- Resolution: 0.0005"/0.01 mm/ 1/128"
- Accuracy: 0.001"/0.02 mm
- X-Large display
- Angle display: 60°, 70°, 80° & 90°
- Great for measure depth of weld or gap
- Battery 3V CR2032 included
- Pouch included

Item # 100-777



IP67 COOLANT CAL
X-LARGE DIGITAL DISPLAY CALIPERS
 WITH OR WITHOUT SMART WIRELESS DATA OUTPUT



- IP67 protective rating:
Water and coolant proof
- Inch/Metric conversion
- Resolution:
0.0005"/0.01 mm / 1/64"
0.0005"/0.01 mm with Smart Wireless
- High contrast LCD display
- Stainless steel frame
- Battery 3V CR2032 included
- Supplied in protective case
- Smart Wireless Data Output connects to Bluetooth device

Item #	Range	Accuracy
100-800-04	0 - 4"/100 mm	0.001"/0.02 mm
100-800-06	0 - 6"/150 mm	0.001"/ 0.02 mm
100-800-08	0 - 8"/200 mm	0.0015"/ 0.03 mm
100-800-12	0 - 12"/300 mm	0.0015"/ 0.03 mm

SMART WIRELESS DATA OUTPUT

Item #	Range	Accuracy
100-800-B04	0 - 4"/100 mm	0.001"/0.02 mm
100-800-B06	0 - 6"/150 mm	0.001"/ 0.02 mm
100-800-B08	0 - 8"/200 mm	0.0015"/ 0.03 mm
100-800-B12	0 - 12"/300 mm	0.0015"/ 0.03 mm

IP67 MICRON DIGITAL CALIPERS
 WITH OR WITHOUT SMART WIRELESS DATA OUTPUT

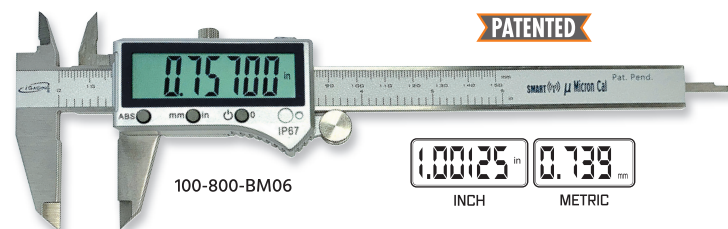

- IP67 protective rating:
Water and coolant proof
- Inch/Metric conversion
- Resolution: 0.00005"/0.001 mm
- High contrast LCD display
- Stainless steel frame
- Battery 3V CR2032 included
- Supplied in protective case
- Smart Wireless Data Output connects to Bluetooth device

Item #	Range	Accuracy
100-800-BM06	0 - 6"/150 mm	0.0008"/0.01 mm
100-800-BM08	0 - 8"/200 mm	0.0010"/0.02 mm
100-800-BM12	0 - 12"/300 mm	0.0010"/0.02 mm

IP54 ORIGINAL ABSOLUTE DIGITAL CALIPERS

WITH SMART WIRELESS DATA OUTPUT

- IP54 protective rating: Moisture and dust resistance
- Absolute encoding technology Memorize absolute origin zero
- Ultra-Response measure speed
- Inch/Metric conversion
- Resolution: 0.0005"/0.01 mm
- High contrast LCD display
- Stainless steel frame
- Battery 3V CR2032 included
- Supplied in protective case
- Smart Wireless Data Output connects to Bluetooth device

ORIGIN ABSOLUTE
SERIES



100-700-B06

Item #	Range	Accuracy
100-700-B04	0 - 4"/100 mm	0.001"/0.02 mm
100-700-B06	0 - 6"/150 mm	0.001"/0.02 mm
100-700-B08	0 - 8"/200 mm	0.0015"/0.03 mm
100-700-B12	0 - 12"/300 mm	0.0015"/0.03 mm

CALIPER DEPTH BASE ATTACHMENTS

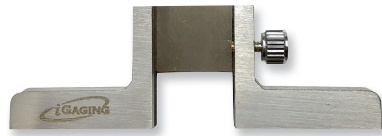

100-D68

T-BAR DEPTH BASE

- Work with regular style 4", 6", 8", 12" calipers
- Stainless steel body
- 5/8" slot width
- Easy to attach
- Lapped flat base
- Screw locking clamp
- Base measurements: 2.94" L x 0.98" H x 0.262" Thick

Item # 100-D68



100-D03

CALIPER DEPTH BASES

- Universal fit with 4", 6", 8", 12" digital calipers
- Stainless steel body
- 0.70" slot width
- Anodized for corrosion resistance
- Easy to attach
- Precision lapped flat base
- Thick base for solid standing position
- Large and strong lock + ultra tight

Item #	Size
100-D03	3" L x 0.855" H x 0.34" thickness
100-D04	4" L x 0.855" H x 0.34" thickness

DIAL & VERNIER CALIPERS

- More than 20 years of caliper making experience
- Premium built calipers with selected quality parts
- Inspected to meet high industrial standards
- Dial calipers are shock proof
- Metric sizes available
- Supplied in protective case.

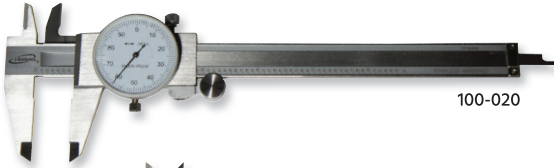

100-020

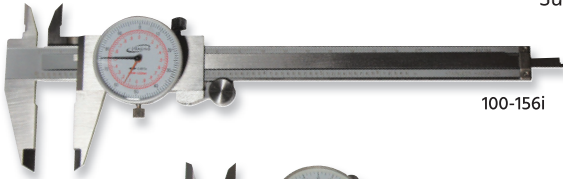

100-156i

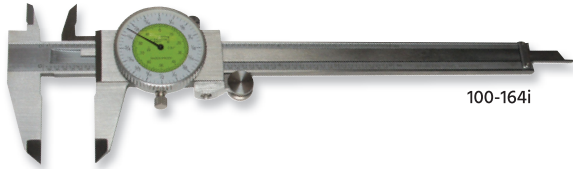

100-164i

DIAL CALIPERS

Item #	Description	Range	Resolution	Accuracy
100-020 *	Dial	0 - 6"	0.001"	0.0015"
100-021 *	Dial	0 - 8"	0.001"	0.0015"
100-022 *	Dial	0 - 12"	0.001"	0.002"
100-156i	Dual Dial	0 - 6"/150 mm	0.001"/0.02 mm	0.0015"
100-164i	Dual Dial	0 - 6"	1/64"/0.01"	0.005"
100-164-8	Dual Dial	0 - 8"	1/64"/0.01"	0.005"
100-164-12	Dual Dial	0 - 12"	1/64"/0.01"	0.005"

*Metric available

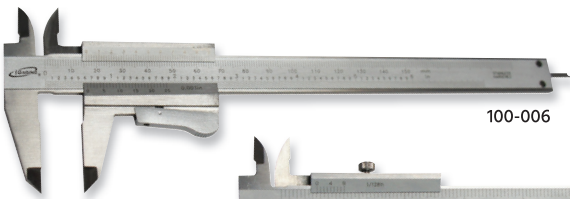

100-006

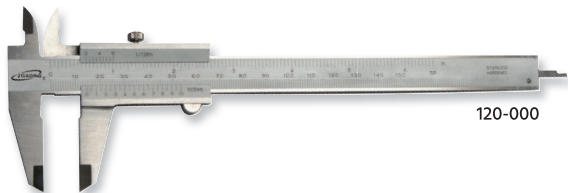

120-000

VERNIER CALIPERS

Item #	Measuring Style	Range	Resolution	Accuracy
100-006	Thumb Lock	0 - 6"	0.001"/0.02 mm	0.0015"
120-001	Thumb Lock	0 - 150 mm	0.05 mm/1/128"	0.0015"
100-007	Screw Lock	0 - 6"	0.001"/0.02 mm	0.0015"
120-000	Screw Lock	0 - 150 mm	0.05 mm/1/128"	0.0015"

IP54 FASTENER CAL DIGITAL CALIPERS

QUICKLY AND ACCURATELY READS COMMON FASTENER SIZES IN INCH AND METRIC

- IP54 protective rating:
Moisture and dust resistance
- Resolution: 0.0005"/0.01 mm/ 1/128"
- Fastener Reading: 1/2", 4th, 8th, 16th, 32nd
- Large and easy to read LCD display
- Stainless steel frame
- Storage/Operating
Temperature: 0 - 40°C
- Battery: 3V CR2032 included
- Supplied in protective case



Item #	Range	Accuracy
100-344-6	0 - 6"/150 mm	0.001"/0.02 mm
100-344-8	0 - 8"/200 mm	0.0015"/ 0.03 mm
100-344-12	0 - 12"/300 mm	0.0015"/ 0.03 mm

ECONOMIC & STUDENT/MEDICAL CALIPERS

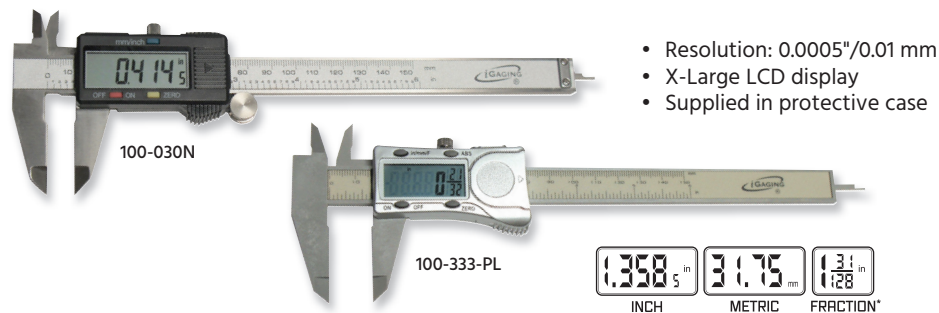

Item #	Material	Range	Accuracy
100-030N	Stainless Steel	0 - 6"/150 mm	0.0015"
100-333-PL*	Poly-Carbon	0 - 6"/0 - 150 mm/ 1/128"	0.003"

*Inch Fraction

CENTERLINE GAUGE

FOR 4", 6" & 8" DIAL, VERNIER & DIGITAL CALIPERS

- Universal fit
- Diameter: 0.375"
- Length: 2.187"
- Slot width: 0.141"
- Corrosion protected coating
- 60° probe tip for hole fitting



Item # 36-C01

CALIPER ACCESSORY KITS

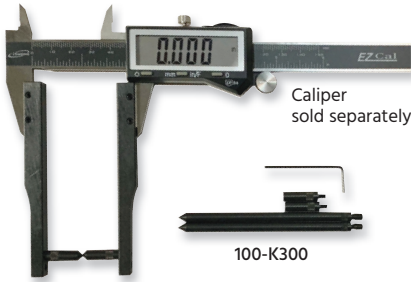

Caliper sold separately

100-K300

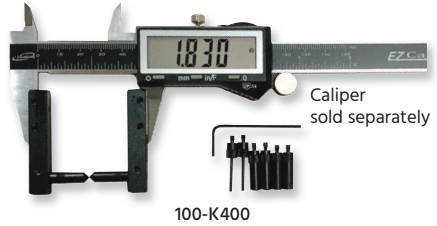

Caliper sold separately

100-K400

- Universal fit for all common 4", 6", & 8" regular vernier, dial, and electronic digital calipers
- Measures slots, grooves, shoulders, holes, webs, & hard to reach areas.
- Corrosion protected coating
- #4-48 thread
- 100-K300 - 9 Piece Kit Includes:
 - 2- Caliper bodies,
 - 1 pair each: cone, large cone and flat points
 - Allen wrench
- 100-K400 - 11 Piece Kit Includes:
 - 2- Caliper bodies,
 - 1 pair each: ball, cone, flat and stem points
 - Allen wrench

Item #	Description	Caliper Case
36-K300	Set of 4 Contacts & Wrench	No
100-K300	Set of 4 Contacts & Wrench	Yes
100-K400	Set of 3 Contacts, Long Reach Arm & Wrench	Yes

ROLLBOT™ MULTI-FUNCTION TAPE-LESS MEASURING GAUGE

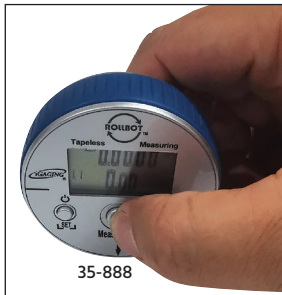

35-888



Measurements

- Linear
- Area
- Cylinder
- Diameter
- Board Feet

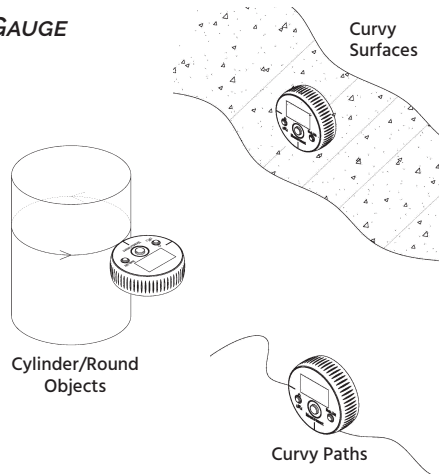

◀◀ Hold & Roll ▶▶

- IP40 protective rating: Solid objects over 1 mm
- Measuring range: 0 - 144"/3.6 m
- Resolution: 0.01"/0.001 m/ 1/32"
- Accuracy: ±0.1% of calculated value
- Measuring speed: 6m/second
- Working temperature: 0 - 40°C
- Metal marking scriber included
- Auto shut-off after 30 minutes
- Battery: CR2032 included

Item # 35-888

WRENCH **iD** + The right size EVERY TIME

Features 3 Functions

Wrench **iD**

Identifies Wrench/Socket sizes in SAE and Metric
1/4 in & 6 mm through 2 1/8 in & 54 mm ranges

Outer Dimensional Measurements in SAE and Metric
0 in & 0 mm through 2 1/8 in & 54 mm ranges

Inner Dimensional Measurements in SAE and Metric
1/2 in & 12.7 mm through 2 19/32 in & 66 mm ranges

Additional Features

LED light

Recall last size

Automatic shut off

Zero/recalibration

For precise measurements every time



WRENCH **iD** +

Additional information visit:

wrenchid.com
xtremetech.com



ITEM# WID-101 (GUNPOWDER GRAY ARMS); WID-102 (NICKEL PLATE ARMS)
PRODUCT OF AND EXCLUSIVELY DISTRIBUTED BY ZUTHER XTREME TECHNOLOGIES

DIGITAL SNAP THICKNESS GAUGES



iGAGING
EXCLUSIVE



- Easy to read LCD display
- HOLD function
- Battery: 3V CR2032 included

DIGITAL SNAPTHICK GAUGE

- Range: 0 - 1"/25 mm
- Resolution: 0.001"/0.02 mm / 1/64"
- Accuracy: ±0.001"
- Spring loaded arm
- Alloy Jaws, chrome finish

DIGITAL SNAP THICKNESS GAUGE

- Range: 0 - 1 1/16"/27 mm
- Resolution: 0.0005"/0.01 mm / 1/64"
- Accuracy: ±0.0015"
- Spring load movement with a push button
- SPC/USB data output

Item #	Contact	Description
35-MT1	Fixed	Digital SnapThick Gauge
35-MT64	2 Flat/1 Ball	Digital Snap Thickness Gauge

ELECTRONIC INSIDE & OUTSIDE CALIPERS

WITH OR WITHOUT EASY-GRIP HANDLE



- iGAGING designed in California
- Resolution: 0.01"/0.1 mm/ 1/64"
- Accuracy: 0.01"
- Spring load movement for fast and easy measurement
- Alloy jaws with chrome finish
- Battery: 3V CR2032 included

Item #	Range	Description
35-ID6	0.5 - 6"	Inside
35-OD6	0 - 6"	Outside

WITH EASY-GRIP HANDLE

Item #	Range	Description
35-ID6-H	0.5 - 6"	Inside
35-OD6-H	0 - 6"	Outside
35-ID8	0.5 - 8"	Inside
35-OD8	0 - 8"	Outside
35-ID-BH	Battery Holder	



DIGITAL THICKNESS GAUGE SETS

- User friendly handle and lever design
- Spring load with quick release action
- 6 interchangeable contact points included
- Resolution: 0.0005"/0.01 mm/ 1/64"
- Accuracy: ±0.001"
- Easy to read large LCD display
- HOLD function
- Battery: 3V CR2032 included
- Supplied in protective case
- Data output available

Item #	Range	Throat Depth
400-TE18	0 - 1"	1"
400-TE48	0 - 1"	4"
35-128-USB	Data Output	



400-TE18

IP65 ORIGIN SPEEDMIC DIGITAL MICROMETERS & SETS

iGAGING
EXCLUSIVE

**ORIGIN ABSOLUTE
SERIES**



35-070-B01



35-070-C01



35-070-D01



35-070-025



35-070-BT1



INCH

METRIC

- IP65 protective rating: Coolants, grit and dust proof
- Inch/Metric conversion
- Resolution: 0.00005"/0.001 mm
- Absolute origin measurement
- DATA output button for easy operation
- SPC/USB data output
- Battery: 3V CR2032 included

- Smart Wireless Data Output connects to Bluetooth device (35-070-BT1)
- Patented lever spring load movement for quick release and accurate measurements
- Supplied in protective case

Item #	Range	Accuracy
35-070-025	0 - 1"/25 mm	0.00015"/0.003 mm
35-070-BT1	0 - 1"/25 mm SmartWireless	0.00015"/0.003 mm
35-070-050	1 - 2"/25 - 50 mm	0.00015"/0.003 mm
35-070-075	2 - 3"/50 - 75 mm	0.00015"/ 0.004 mm
35-070-100	3 - 4"/75 - 100 mm	0.00015"/ 0.004 mm
35-070-313	0 - 3" Set w/Fitted Plastic Case	
35-070-314	0 - 4" Set w/Fitted Plastic Case	



PATENTED

Item #	Anvil Type	Range	Accuracy
35-070-B01	Blade	0 - 1"/25 mm	0.00015"/0.003 mm
35-070-B02	Blade	1 - 2"/25 - 50 mm	0.00015"/0.003 mm
35-070-C01	Point	0 - 1"/25 mm	0.00015"/0.003 mm
35-070-C02	Point	1 - 2"/25 - 50 mm	0.00015"/0.003 mm
35-070-D01	Disc	0 - 1"/25 mm	0.00015"/0.003 mm
35-070-D02	Disc	1 - 2"/25 - 50 mm	0.00015"/0.003 mm
35-070-D03	Disc	2 - 3"/50 - 75 mm	0.00015"/0.004 mm
100-700-USB	SPC/USB Cable Data Kit		
35-WL-USB	Wireless Dongle Data Kit (Dongle to USB Flash Drive)		
35-BT-28	BT Wireless Dongle Data Kit (Dongle to Device)		

IP65 EZ DATA TWIN-FORCE DIGITAL MICROMETERS & SETS

- IP65 protective rating:
Coolants, grit and dust proof
- Twin force movement:
Friction and Ratchet
- Inch/Metric conversion
- Resolution: 0.00005"/0.001 mm
- Micro USB data output
- Black Anodized friction tube
for easy grip & easy clean
- Battery: 3V CR2032 included
- Supplied in protective case



35-065-U01



PREMIUM
BUILT



Item #	Range	Accuracy
35-065-U01	0 - 1"/25 mm	0.00015"/0.003 mm
35-065-U02	1 - 2"/25 - 50 mm	0.00015"/ 0.003 mm
35-065-U03	2 - 3"/50 - 75 mm	0.00015"/ 0.004 mm
35-065-U04	3 - 4"/75 -100 mm	0.00015"/ 0.004 mm
35-065-U33	0 - 3" Set/Plastic Case	
35-065-U44	0 - 4" Set/Plastic Case	
100-700-USB-MC	Micro USB Data Kit	
35-BT28-MC	Micro USB Wireless Kit	

IP54 SMARTMIC ELECTRONIC DIGITAL MICROMETER WITH BUILT-IN SMART WIRELESS DATA OUTPUT

- IP54 protective rating:
Moisture and dust resistance
- X-Large LCD display
- Criterion A for ESD
- Inch/Metric conversion
- Resolution: 0.00005"/0.001 mm
- Absolute/Incremental setting
- DATA output button for easy operation
- All metal ratchet stop
- SPC/USB data output
- Battery: 3V CR2032 included
- Supplied in protective case
- Smart Wireless Data Output
connects to Bluetooth device



35-054-B01



Item #	Range	Accuracy
35-054-B01	0 - 1"/25 mm	0.00015"/0.003 mm
100-700-USB	SPC/USB Cable Data Kit	
35-WL-USB	Wireless Dongle Data Kit (Dongle to Flash Drive)	
35-BT-28	BT Wireless Dongle Data Kit (Dongle to Device)	

SPC
Data Output

IP54 EZ DATA ELECTRONIC DIGITAL SPECIALTY MICROMETERS

NEW



35-054-SP01



35-054-UT1



35-054-US1

SPC
Data Output



INCH

METRIC

iGAGING
EXCLUSIVE



- IP54 protective rating:
Moisture and dust resistance
- X-Large LCD display
- Criterion A for ESD
- Inch/Metric conversion
- Resolution: 0.00005"/0.001 mm
- Accuracy: 0.00015"/0.003 mm
- Absolute/Incremental setting
- DATA output button for easy operation
- All metal ratchet stop
- SPC/USB data output
- Battery: 3V CR2032 included
- Supplied in protective case

Item #	Description	Range
35-054-SP01	Pin Tube	0 - 1"/25 mm
35-054-UT1	Barrel Tube	0 - 1"/25 mm
35-054-UB1	Blade	0 - 1"/25 mm
35-054-UB2	Blade	1" - 2"/25 - 50 mm
35-054-US1	Spline	0 - 1"/25 mm
35-054-US1	Spline	1" - 2"/25 - 50 mm

NEW ITEMS



35-3PG-120
Tri-Point Pistol Grip
Internal Micrometer
Pg. 35

90°
ROTATION
DISPLAY



330°
ROTATION
DISPLAY



35-DB-160
Absolute Tri-Point
Digital Internal
Bore Gauge
w/Hand Grip
Pg. 34

35-040-SP01
Pin Tube
Thickness Micrometer
Pg. 16



IP40 ELECTRONIC DIGITAL MICROMETERS & SETS



35-040-025



35-040-050



35-040-075



35-040-100



35-040-125



INCH

METRIC



35-040-213



35-040-214



Micro USB
Data Output



35-040-216

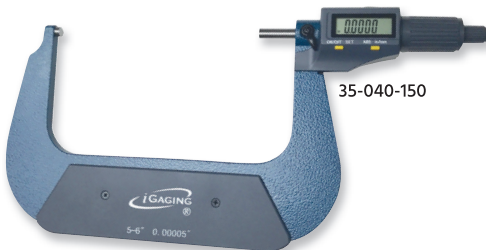

35-040-150

- IP40 protective rating: Solid objects over 1 mm
- Large LCD display
- Criterion A for ESD
- Inch/Metric conversion
- Resolution: 0.00005"/0.001 mm
- Absolute/Incremental setting
- Micro USB data output
- Battery: 3V CR2032 included
- Supplied in protective case

Item #	Range	Accuracy
35-040-025	0 - 1"/25 mm	0.00015"/0.003 mm
35-040-050	1 - 2"/25 - 50 mm	0.00015"/0.003 mm
35-040-075	2 - 3"/50 - 75 mm	0.00015"/0.004 mm
35-040-100	3 - 4"/75 - 100 mm	0.00015"/0.004 mm
35-040-125	4 - 5"/100 - 125 mm	0.0002"/0.005 mm
35-040-150	5 - 6"/125 - 150 mm	0.0002"/0.005 mm
35-040-213	0 - 3" Set/Plastic Case	
35-040-214	0 - 4" Set/Plastic Case	
35-040-216	0 - 6" Set/Metal Case	
35-025-USB	Micro USB Data Kit	

ELECTRONIC SPECIALTY DIGITAL MICROMETERS



IP40

IP54



- IP40 protective rating: Solid objects over 1 mm
- IP54 protective rating: Moisture and dust resistance
- LCD display
- Criterion A for ESD
- Inch/Metric conversion
- Resolution: 0.00005"/0.001 mm
- Accuracy: 0.00015"/0.03 mm
- Absolute/Incremental setting
- Micro USB data output
- Battery: 3V CR2032 included
- Supplied in protective case

Micro USB
Data Output

Item #	Description	Range
35-040-201	IP40 Double Point Micrometer	0 - 1"/25 mm
35-054-SP01	IP54 Pin Tube Thickness Micrometer	0 - 1"/25 mm
35-054-401	IP54 Barrel Tube Thickness Micrometer	0 - 1"/25 mm
35-040-T01	IP40 Barrel Tube Thickness II Micrometer	0 - 1"/25 mm
35-040-317	IP40 Disc Rotor Micrometer - 3.4" Throat Depth	0.7 - 1.7"
35-230e	IP40 Disc Rotor Micrometer - 3.4" Throat Depth	0.3 - 1.3"
35-040-301	IP40 Electronic Digital Micrometer Head	0 - 1"/25 mm
35-054-646	IP54 Depth Micrometer	0 - 6"/125 mm
35-025-USB	Micro USB Data Kit	

DIGIT OUTSIDE MICROMETERS & SET

- Graduation: 0.0001"
- Carbide measuring faces
- Painted steel frame with heat shield
- Ratchet thimble
- Spindle lock
- Standards included in 1 - 2" and larger
- Set accuracy: $\pm 0.0002''$
- Supplied in protective case

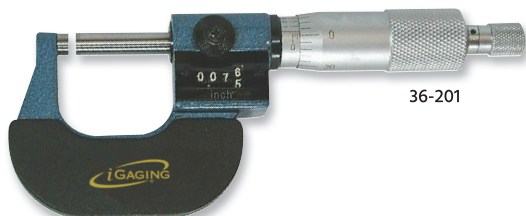

36-201



36-213

Item #	Range	Accuracy
36-201	0 - 1"	$\pm 0.0001''$
36-202	1 - 2"	$\pm 0.0002''$
36-203	2 - 3"	$\pm 0.0002''$
36-213	0 - 3" Set/Plastic Case	

OUTSIDE MICROMETERS & SETS



36-114

- Graduation: 0.0001"
- Carbide measuring faces
- Painted steel frame with heat shield
- Ratchet thimble
- Spindle lock
- Standards included in 1 - 2" and larger
- Sets accuracy: $\pm 0.0002''$
- Supplied in protective case

Item #	Range	Accuracy
36-101	0 - 1"	$\pm 0.0001''$
36-102	1 - 2"	$\pm 0.0002''$
36-103	2 - 3"	$\pm 0.0002''$
36-113	0 - 3" Set/Plastic Case	
36-114	0 - 4" Set/Plastic Case	
36-116	0 - 6" Set/Aluminum Case	
36-679-12	6 - 12" Set/Wood Case	

IP54 ABSOLUTE ORIGIN DIGITAL INDICATORS

WITH OR WITHOUT SMART WIRELESS DATA OUTPUT

ORIGIN ABSOLUTE
SERIES

IP54



35-700-10

SPC
Data Output



35-700-B10
Built-In
Smart Wireless



35-700-25

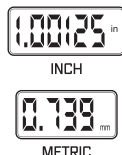

35-700-50



- IP54 protective rating: Moisture and dust resistance
- Absolute encoding technology Memorize absolute origin zero
- Ultra-Response measure speed
- Inch/Metric conversion
- High contrast LCD display
- 330° display rotation.
- Preset and tolerance function
- Stem dia.: 3/8"
- Thread size: #4-48

- Ceramic contact point
- Attachable finger lever included (except for 0 - 0.5" sizes)
- Lug and flat back included
- SPC/USB data output
- Battery: 3V CR2032 included
- Supplied in protective case
- Smart Wireless Data Output connects to Bluetooth device

Item #	Range	Resolution	Accuracy	Repeatability
35-700-10	0 - 0.5"/12.7 mm	0.00005"/0.001 mm	0.00016"/0.004 mm	0.00005"
35-705-10	0 - 0.5"/12.7 mm	0.0005"/0.01 mm	0.0005"/0.01 mm	0.0005"
35-700-25	0 - 1"/25.4 mm	0.00005"/0.001 mm	0.00016"/0.004 mm	0.00005"
35-705-25	0 - 1"/25.4 mm	0.0005"/0.01 mm	0.0005"/0.01 mm	0.0005"
35-700-50	0 - 2"/50.8 mm	0.00005"/0.001 mm	0.0002"/0.005 mm	0.00005"
35-705-50	0 - 2"/50.8 mm	0.0005"/0.01 mm	0.001"/0.015 mm	0.0005"
100-700-USB	SPC/USB Cable Data Kit			
35-WL-USB	Wireless Dongle Data Kit (Dongle to USB Flash Drive)			
35-BT-28	BT Wireless Dongle Data Kit (Dongle to Device)			

SMART WIRELESS DATA OUTPUT

Item #	Range	Resolution	Accuracy	Repeatability
35-700-B10	0 - 0.5"/12.7 mm	0.00005"/0.001 mm	0.00016"/0.004 mm	0.00005"
35-705-B10	0 - 0.5"/12.7 mm	0.0005"/0.01 mm	0.0005"/0.01 mm	0.0005"
35-700-B25	0 - 1"/25.4 mm	0.00005"/0.001 mm	0.00016"/0.004 mm	0.00005"
35-705-B25	0 - 1"/25.4 mm	0.0005"/0.01 mm	0.0005"/0.01 mm	0.0005"
35-700-B50	0 - 2"/50.8 mm	0.00005"/0.001 mm	0.0002"/0.005 mm	0.00005"
35-705-B50	0 - 2"/50.8 mm	0.0005"/0.01 mm	0.001"/0.015 mm	0.0005"

IP65 ABSOLUTE-INDI DIGITAL INDICATOR PROBES

ORIGIN ABSOLUTE
SERIES

IP65



Rear View



35-950-99
Removable Lug Back



35-955-10



35-955-25



35-950-50



35-950-99

SPC
Data Output



INCH

METRIC

- IP65 protective rating: Coolants, grit and dust proof
- Absolute encoding technology Memorize absolute origin zero
- Ultra-Response measure speed
- Inch/Metric conversion
- High contrast LCD display
- Preset button
- Stem dia.: $\frac{3}{8}$ "
- Thread size: #4-48

- Ceramic contact point
- Attachable finger lever included (except for 0 - 0.5" sizes)
- Lug and flat back included
- Attachable finger lever included (except for 0 - 0.5" sizes)
- SPC/USB data output
- Battery: 3V CR1632 included
- Supplied in protective case



Finger Lift

Item #	Range	Resolution	Accuracy	Repeatability
35-950-10	0 - 0.5"/12.7 mm	0.00005"/0.001 mm	0.00016"/0.005 mm	0.00005"/0.001 mm
35-955-10	0 - 0.5"/12.7 mm	0.0005"/0.01 mm	0.0005"/0.01 mm	0.0005"/0.01 mm
35-950-25	0 - 1"/25.4 mm	0.00005"/0.001 mm	0.0016"/0.005 mm	0.00005"/0.001 mm
35-955-25	0 - 1"/25.4 mm	0.0005"/0.01 mm	0.0005"/0.01 mm	0.0005"/0.01 mm
35-950-50	0 - 2"/50.8 mm	0.00005"/0.001 mm	0.0002"/0.006 mm	0.00005"/0.001 mm
35-955-50	0 - 2"/50.8 mm	0.0005"/0.01 mm	0.0005"/0.015 mm	0.0005"/0.01 mm
35-950-99	0 - 4"/101.6 mm	0.00005"/0.001 mm	0.0003"/0.01 mm	0.0001"/0.002 mm
35-955-99	0 - 4"/101.6 mm	0.0005"/0.01 mm	0.001"/0.02 mm	0.0005"/0.01 mm
100-700-USB	SPC/USB Cable Data Kit			
35-WL-USB	Wireless Dongle Data Kit (Dongle to USB Flash Drive)			
35-BT-28	BT Wireless Dongle Data Kit (Dongle to Device)			

IP65 ABSOLUTE ORIGIN INDICATOR PROBES WITH REMOTE DIGITAL READOUT

**iGAGING[®]
EXCLUSIVE**

35-958-99



**ORIGIN ABSolute
SERIES**

35-958-50



SPC Data Output

IP 65

35-958-10



Rear View

- IP65 protective rating: Coolants, grit and dust proof
- Absolute encoding technology Memorize absolute origin zero
- Ultra-Response measure speed
- Gauge is sealed for remote and tough environment, remote access display included
- Inch/Metric conversion
- Remote readout LCD display with 48" cable

- Preset button
- Hold button
- Stem dia.: $\frac{3}{8}$ "
- Thread size: #4-48
- Ceramic contact point
- Removable lug back included
- Attachable finger lever included (except for 0 - 0.5" sizes)
- SPC/USB data output
- Battery: 3V CR2032 included
- Supplied in protective case



Item #	Range	Resolution	Accuracy	Repeatability
35-958-10	0 - 0.5"/12.7 mm	0.00005"/0.001 mm	0.0016"/0.005 mm	0.00005"/0.001 mm
35-999-10	0 - 0.5"/12.7 mm	0.0005"/0.01 mm	0.0005"/0.01 mm	0.0005"/0.01 mm
35-958-25	0 - 1"/25.4 mm	0.00005"/0.001 mm	0.0016"/0.005 mm	0.00005"/0.001 mm
35-999-25	0 - 1"/25.4 mm	0.0005"/0.01 mm	0.0005"/0.01 mm	0.0005"/0.01 mm
35-958-50	0 - 2"/50.8 mm	0.00005"/0.001 mm	0.0002"/0.006 mm	0.00005"/0.001 mm
35-999-50	0 - 2"/50.8 mm	0.0005"/0.01 mm	0.0005"/0.015 mm	0.0005"/0.01 mm
35-958-99	0 - 4"/101.6 mm	0.00005"/0.001 mm	0.0003"/0.01 mm	0.0001"/0.002 mm
35-999-99	0 - 4"/101.6 mm	0.0005"/0.01 mm	0.001"/0.02 mm	0.0005"/0.01 mm
100-700-USB	SPC/USB Cable Data Kit			
35-WL-USB	Wireless Dongle Data Kit (Dongle to USB Flash Drive)			
35-BT-28	BT Wireless Dongle Data Kit (Dongle to Device)			

IP67 HIGH RESOLUTION DIGITAL INDICATORS

WITH OR WITHOUT SMART WIRELESS DATA OUTPUT



- IP67 protective rating: Water and coolant proof
- Absolute encoding technology Memorize absolute origin zero
- Ultra-Response measure speed
- Inch/Metric conversion
- Easy to read LCD display
- Preset and tolerance function
- +/- measurement direction switch
- Stem dia.: 3/8"
- Thread size: #4-48
- Carbide contact point
- Lug and flat back included
- Attachable finger lever included (except for 0 - 0.5" sizes)
- Auto shut-off
- Micro USB data output port (Cable for charging or data output option included)
- Power: 3V CR2032 battery included/ Micro USB charging
- Inspection certificate with graphic chart available
- Supplied in protective case

Item #	Range	Accuracy
35-A67-12	0 - .5"/12.7 mm	0.0003"/0.007 mm
35-A67-25	0 - 1"/25 mm	0.00035"/0.008 mm
35-A67-50	0 - 2"/50 mm	0.0004"/0.01 mm
35-A67-99	0 - 4"/101 mm	0.0004"/0.01 mm
100-630-USB	Micro USB Data Output Kit	
35-WL-MC	Wireless Dongle Data Kit (Dongle to Flash Drive)	
35-BT-MC	Smart Wireless Data Output Kit	

SMART WIRELESS DATA OUTPUT TO SMART APP

Item #	Range	Accuracy
35-B67-12	0 - .5"/12.7 mm	0.0003"/0.007 mm
35-B67-25	0 - 1"/25 mm	0.00035"/0.008 mm
35-B67-50	0 - 2"/50 mm	0.0004"/0.01 mm
35-B67-99	0 - 4"/101 mm	0.0004"/0.01 mm

EZ-INDI DIGITAL INDICATORS

- Absolute/Increment measuring
- Accuracy: 0.0015"
- Stem dia.: $\frac{3}{8}$ "
- Thread size: #4-48
- Carbide contact point
- 35-125-4 includes four contacts: ball, point, small flat and large flat
- Lug and flat back included
- Micro USB data output port
- Battery: 3V CR2032 included
- Supplied in protective case



Item #	Range	Resolution	Function
35-126	0 - .5"/12.7 mm	0.0005"/0.01 mm	Tolerance
35-125-i	0 - 1"/25 mm	0.0005"/0.01 mm	Tolerance
35-125-4*	0 - 1"/25 mm	0.0005"/0.01 mm	Tolerance
35-128	0 - 1"/25 mm	0.0005"/0.01 mm/ $\frac{1}{128}$ "	Hold
35-128-USB	Micro USB Data Output Cable		

* Includes four contacts



INDICATOR COMPARATOR STANDS

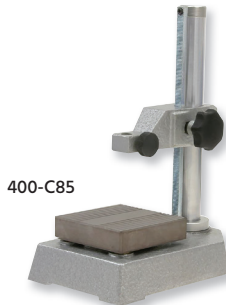
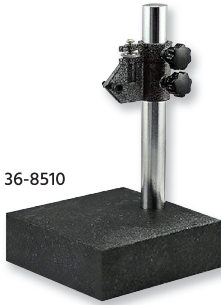

GRANITE BASE

- Flatness: 0.00005"
- 7 $\frac{3}{4}$ " high column, 1" diameter
- Rapid positioning
- Fine adjustment
- Works with all lugback ADG indicators

Item #	Size
36-8510	6 x 6 x 2" Base
36-8520	6 x 8 x 2" Base

CERAMIC SURFACE

- Highly accurate
- Temperature resistance
- Travel height: 8"
- Measuring surface: 85 x 85 x 20 mm

Item # 400-C85

STAINLESS STEEL SURFACE

- Hardened and precision ground
- Travel height: 8"
- Measuring surface: 85 x 85 x 20 mm

Item # 400-S85

INDICATOR ACCESSORIES

INDICATOR MAGNETIC BACK

- Powerful magnetic back
- Direct mount of AGD dial indicators
- Dial indicator sold separately

Item # 34-0MB



34-0MB

22 PC. INDICATOR POINT KIT

- Wide section of contact points flat, bent, half round, taper, ball
- Thread size: #4-48
- Chrome finish
- Supplied in protective case

Item # 36-022



36-022

INDICATOR DEPTH BASE

- Wide section of contact points flat, bent, half round, taper, ball
- Base length: 4"
- Works with $\frac{3}{8}$ " diameter hole AGD and most of iGAGING indicators

Item # 100-D69

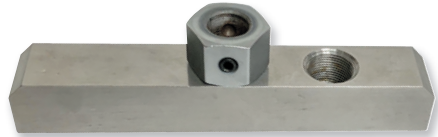

100-D69

INDICATOR FINGER LEVER

- Finger lever for long range indicators
- Easy attachment
- Makes precise movement
- Included in all 0-2" and 0-4" long range iGAGING absolute indicators.

Item # 35-7XX-HL



35-7XX-HL



36-MS6

MICROMETER STAND

- Fits 0.5" - 4" micrometers
- Free up one hand when using micrometer with the stand
- Makes the micrometer easier to operate
- Tilt position adjustment
- Made of aluminum

Item # 36-MS6

FRACTIONAL & DECIMAL DUEL SCALE DIAL INDICATORS



400-0164



PREMIUM
BUILT

- Exclusive iGAGING California design
- iGAGING 10 Years of Excellency Special Edition
- Dual dial indication
- Thread size: #4-48
- Stem dia.: $\frac{3}{8}$ "
- 3-Way reading dial indicator: 0.001" (outer scale)
 $\frac{1}{64}$ " (middle)
0.1 (inner)

Item #	Range
--------	-------

400-0164	0 - 1"
400-0264	0 - 2"

PRECISION DEPTH GAUGE SETS

DIAL & DIGITAL

- Range: 0 - 22"
- Thread size: #4 - 48
- 1", 2", 3", 4", 5" and 6" extensions included
- Ball, point and flat contacts included
- 4" base with two indicator mounting positions
- Supplied in protective case.



400-D68

DIAL DEPTH GAUGE SET

- Dial reading: 0 - 50
- Resolution: 0.0005"
- Revolution counter

DIGITAL DEPTH GAUGE SET

- Absolute and incremental reading
- Resolution: 0.0005"/0.01 mm/ $\frac{1}{128}$ "
- Accuracy: ± 0.001 "
- Easy to read LCD display
- Auto shut-off
- Battery: 3V CR2032 included



400-D69



INCH

METRIC

FRACTION

Item #	Description
--------	-------------

400-D68	Dial Precision Depth Gauge Set
---------	--------------------------------

400-D69	Digital Precision Depth Gauge Set
---------	-----------------------------------

PREMIUM DIAL INDICATORS



- Thread size: #4-48
- Stem dia.: $\frac{3}{8}$ "
- Accuracy: $2\frac{2}{3}$ revolution, 1 graduation
- Hard Chrome finish
- Standard sized lug back
- Meet or exceed Federal specifications
- IP65 Protective rating model available

**QUALITY
BUILT**

Item #	Range	Graduation	Face Color
400-010	0 - 10mm	0.01 mm	White
400-025	0 - 25mm	0.01 mm	White
400-001	0 - 1"	0.001"	White
400-002	0 - 2"	0.001"	White
400-005	0 - 1"	0.0005"	White
400-065-05i*	0 - 1"	0.0005"	Black
400-065-01*	0 - 1"	0.001"	White

*IP65 Protective Rating

IP54 DIGIDEPTH & ABSOLUTE ORIGIN DEPTH GAUGES

MEASURING RANGE UP TO 16" WITH INTERCHANGEABLE RODS

**ORIGIN Absolute
SERIES**

**iGAGING
EXCLUSIVE**



35-0917

- IP54 protective rating: Moisture and dust resistance
- Range: 0 - 6"/150 mm
- Range with extensions: 0 - 16"/400 mm
- Accuracy: 0 - 1"/0.001"
- Thread size: #4 - 48
- 1", 2", 3", 4" and 5" extensions included
- Integrated lug back
- Base: 2" L x $\frac{1}{4}$ " W
- Auto shut-off after 5 minutes
- Battery: 3V CR2032 included
- Supplied in protective case.

DIGIDEPTH GAUGE (35-0917)

- Resolution: 0.0005"/0.01 mm / $\frac{1}{64}$ "
- Large LCD display



35-0918

35-0904

ABSOLUTE ORIGIN DEPTH GAUGE (35-0918)

- Absolute encoding technology
- Memorize absolute origin zero
- Resolution: 0.0005"/0.01 mm / $\frac{1}{128}$ "
- Easy to read LCD display
- SPC/USB data output

Item #	Description
35-0917	DigiDepth Gauge
35-0918	Absolute Origin Depth Gauge
35-0904	0 - 4" Digital Snap Depth Gauge
100-700-USB	SPC/USB Cable Data Kit for 35-0918

IP67 0.30" & 0.008"

ELECTRONIC DIGITAL TEST INDICATORS

PATENT Pending

WITH OR WITHOUT SMART WIRELESS DATA OUTPUT

- IP67 protective rating: Water and coolant proof
- Inch/Metric conversion
- Analog display for movement and travel direction with indicator icon
- $\frac{3}{8}$ " & $\frac{5}{32}$ " dovetail stems included
- 360° digital rotation
- Large LCD digital display
- Auto shut-off
- Micro USB data output port (Cable for charging or data output option included)
- Power: 3V CR2032 battery included/ Micro USB charging
- Inspection certificate with graphic chart available
- Supplied in protective case

iGAGING
EXCLUSIVE

360° ROTATION DISPLAY

35-B67-T30

0.0358" INCH 3.175 mm METRIC



IP67

Item #	Range	Resolution	Accuracy
35-A67-T30	0 - 0.030"/0.75 mm	0.0005"/0.01 mm	0.0001"/0.01 mm
35-A67-T08	0 - 0.008"/0.2 mm	0.0001"/0.001 mm	0.0002"/0.005 mm
35-630-USB	Micro USB Data Output Kit		

SMART WIRELESS DATA

Item #	Range	Resolution	Accuracy
35-B67-T30	0 - 0.030"/0.75 mm	0.0005"/0.01 mm	0.0001"/0.01 mm
35-B67-T08	0 - 0.008"/0.2 mm	0.0001"/0.001 mm	0.0002"/0.005 mm

SMART Gauge

SPC
Data Output
AC Power

PREMIUM DIAL TEST INDICATORS

- Range: 0.030"
- Graduation: 0.0005"
- Reading: 0-15-0
- Face dia.: 1 1/4"
- Satin chrome finish
- Universal positioning contact
- 3-side standard dovetail mount
- Jeweled movement
- Meet or exceed Federal specifications
- $\frac{3}{8}$ " & $\frac{5}{32}$ " dovetail stems included
- Contact point: 0.080" dia x 1/2" length
- 400-065-030-i: IP67 protective rating: Water and coolant proof
- Supplied in protective case.

QUALITY BUILT

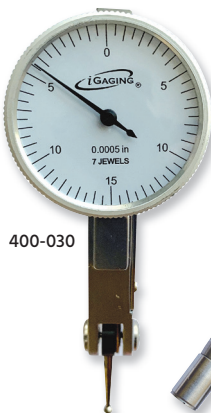

400-030



400-065-030-i

IP65

Item #	Description
400-030	Dial Test Indicator
400-065-030-i	iP65 Dial Test Indicator

EXTENDED RANGE DIAL TEST INDICATORS

- Range: 0.060"
- Graduation: 0.0005"
- Reading: 0-15-0
- Face dia.: 1½"
- Satin chrome finish
- Universal positioning contact
- 2-side standard dovetail mount
- Jeweled movement
- Meet or exceed Federal specifications
- ¾" & 5/32" dovetail stems included
- Contact point: 0.080" dia x ½" length
- 400-065-060-i: IP65 protective rating: Coolants, grit and dust proof
- Supplied in protective case.

**QUALITY
BUILT**

IP65

400-065-060-i



400-060

Item #	Description
--------	-------------

400-060	Extended Dial Test Indicator
---------	------------------------------

400-065-060-i	iP65 Extended Dial Test Indicator
---------------	-----------------------------------

CO-AX CENTERING INDICATOR

TO QUICKLY CENTER WORK PIECES OR FIXTURES ON YOUR MILL

- Length: 5½"
- Shank dia.: ¾"
- Feeler dia.: ⅛"
- Measuring range: 0.25" of axis
- Dial reading: 0 - 50
- Graduation: 0.0005"
- Includes 6 Feelers: 4", 8", 12" Straight
4", 8", 12" Curved
- Capacity: ¾" - 4¼" internal
0 - 4¼" external
- Locating Accuracy is 0.0005" of center
- Operates at any angle from horizontal to vertical without any change, and from internal to external by simply changing the feeler
- Supplied in a fitted wood case
- This set includes: Indicator body, restraining rod (prevents rotation), spring-loaded center point feeler, three straight feelers (for IDs), three curved feelers (for ODs)



400-C02

Item #	Description
--------	-------------

400-C02	Inch CO-AX Centering Indicator Set
---------	------------------------------------

400-C02-M	Metric CO-AX Centering Indicator Set
-----------	--------------------------------------

TEST INDICATOR HOLDER & SET

- Centering rod dia: 0.375" x 1.55" for milling machines
- Arm length: 2" top, 1.9" bottom.
- Universal fine adjustment
- Strong locking handle
- Holds indicator with $\frac{3}{8}$ " stem and dovetail
- Red anodized finish
- Set includes Dial Test Indicator #400-065-030-i
- Supplied in protective case



400-U37

Item #	Description
400-U37	Test Indicator & Holder Set
34-U07-P	Test Indicator Holder Only

DIAL INDICATORS, HOLDERS & MINI MAGNETIC BASE SETS

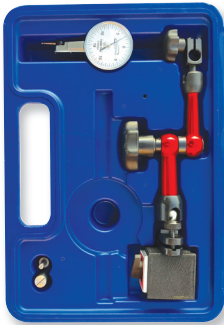

400-U37-MB

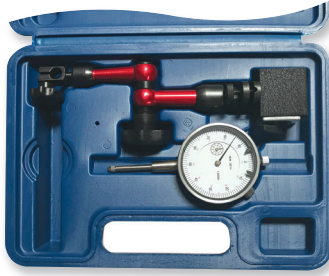

400-U01-MB

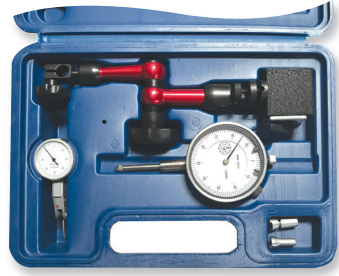

400-U0137-MB

- Magnetic base: 1.2" x 1.17" x 1.38" H
- Arm length: 1.93" top, 2.1" bottom
- Universal fine adjustment
- Strong locking handle
- Holds indicators with $\frac{3}{8}$ " stem and dovetail
- Red anodized finish
- 70 lbs. pulling power
- On/Off switch
- Supplied in protective case

DIAL TEST INDICATOR (400-030)

- Range: 0 - 0.030"
- Reading: 0-15-0
- Graduation: 0.0005"

DIAL INDICATOR (400-001)

- Range: 0 - 1"
- Reading: 0 - 100
- Graduation: 0.001"
- Accuracy: 0.001"

Item #	Description
400-U37-MB	Mini Mag Base w/Test Indicator (400-030) Set
400-U01-MB	Mini Mag Base w/Dial Indicator (400-001) Set
400-U0137-MB	Mini Mag Base w/Dial Indicators (400-030 & 400-001) Set
34-U07-MB	Indicator Holder & Mini Mag Base

DIAL/DIGITAL INDICATOR, HOLDER & MAGNETIC BASE SETS WITH FINE ADJUSTMENT OR FLEX ARM HOLDER



34-510



35-510



35-102

- Indicator range: 0 - 1"
- Fine Adjustment holder: 7" x 1/4" dia. vertical bar, 6" x 3/8" dia. cross bar
- Flex Arm holder: 12" long with lever lock
- On/Off switch
- V-Groove base allows mounting on cylindrical surfaces
- Magnetic pull: 80 lbs.
- Base size: 2 1/2" L x 2" W x 2 1/8" H
- Supplied in protective case

FINE ADJUSTMENT HOLDER SET

Item #	Indicator	Graduation/Reading	Accuracy
34-510	Dial (400-001)	0.001"	0.001"
35-510	Digital (35-128)	0.0005"/ 0.01 mm/ 1/128"	0.001"

FLEX ARM HOLDER SET

Item #	Indicator	Graduation/Reading	Accuracy
34-102	Dial (400-001)	0.001"	0.001"
35-102	Digital (35-128)	0.0005"/ 0.01 mm/ 1/128"	0.001"



34-102

MAGNETIC BASE INDICATOR HOLDER SET

DIAL INDICATOR

- Range: 0 - 1"
- Resolution: 0.001"
- Graduations: 001" per line, 0.1" per revolution
- Face dia.: 2 1/4"
- Built to AGD specifications
- Vertical lug back configuration
- Holds indicators with 3/8" stem and dovetail

BASE FEATURES

- Size: 1.8" x 1.65" x 1.35" H
- Arm length: 4.5" top, 4.5" bottom
- 70 lbs. pulling power
- Supplied in protective case

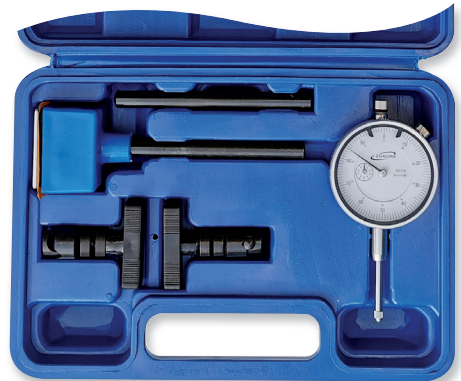

34-101

Item # 34-101

MAGNETIC BASE HOLDERS WITH SPECIALTY ARMS

WITH INDICATOR MOUNTING CLAMPS

- V-Groove base allows mounting on cylindrical surfaces
- On/Off switch
- Magnetic pull: 125 lbs.
- Base size: 2½" L x 2" W x 2⅛" H

FINE ADJUSTMENT ARM - 34-001

- 12" reach
- Fine adjustment knob
- Accepts indicators with ⅜"/8 mm stems, lug backs, and dovetails.



34-001



34-002

UNIVERSAL ARM - 34-002

- 15" total reach
- Accepts indicators with ⅜"/8 mm stems, lug backs, and dovetails
- Set into any position with a single knob
- Fine Adjustment

FLEX ARM - 34-102-N

- 12" flex arm rotates 360°
- Indicator mount with ½" max. capacity
- Accepts all AGD indicators
- Cam lever locks arm in any position



34-102-N

Item #	Description
34-001	Fine Adjustment Arm w/Magnetic Base
34-002	Universal Arm w/Magnetic Base
34-102-N	Flex Arm w/Magnetic Base

ANYSURFACE MAGNETIC BASE

- The magnetic stand adapts itself to any shape or contour, M8 mounting hole
- 70 steel segments independently align and attach themselves firmly to uneven surfaces
- Single cam lock lever securely locks segments in adapted form
- Dimension: 2½" L x 2" W x 1¾" H



34-008



HANDLE ATTACHMENT

- M8 x 1¼" thread

Item #	Description
34-008	AnySurface Magnetic Base
34-000	Magnetic Base
34-000-H	Handle Attachment for 34-000, 34-008

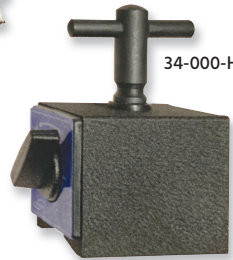

34-000

IP54 ABSOLUTE ORIGIN DIGITAL HEIGHT GAUGES



ORIGIN ABSolute
SERIES

PATENTED

HD Display

- Absolute encoding technology
Memorize absolute origin zero
- Ultra-Response measure speed
- Zero setting at any position
- Large LCD display
- Inch/Metric conversion at any position
- Indicator bar for travel included
- Single stainless steel beam with smooth slider hand wheel for optimize movement
- Carbide tipped scriber
- Data cable to connect indicators to height gauge included
- SPC/USB data output
- Manual On/Off power
- Power:
3V CR2032 battery included/
AC power
- Supplied in protective case



Computer not included



35-700-H24

Item #	Range	Accuracy
35-700-H12	0 - 12"/300 mm	0.001"/0.03 mm
35-700-H18*	0 - 18"/450 mm	—
35-700-H24	0 - 24"/600mm	0.002"/ 0.05 mm
100-700-USB	SPC/USB Cable Data Kit	
35-WL-USB	Wireless Dongle Data Kit (Dongle to Flash Drive)	
35-BT-28	BT Wireless Dongle Data Kit (Dongle to Device)	

*Special order



INCH



METRIC



Read on
Smart Device



***ULTRA ACCURATE SOLUTIONS**

- By connection to the available iGAGING Micron absolute indicator or indicator probes, the height gauge will be able to measure and read objects in micron level.
- For additional information, please check:
 - iGAGING Absolute Indicators
 - iGAGING Absolute Indicator Probe

IP54 MINI ABSOLUTE ORIGIN DIGITAL HEIGHT GAUGES

0 - 12"/300 MM MEASURING RANGE

- IP54 protective rating: Moisture and dust resistance
- Absolute encoding technology Memorize absolute origin zero
- Ultra-Response measure speed
- Resolution: 0.0005"/0.01 mm
- Accuracy: 0.002"/0.04 mm
- Indication variability: 0.0005"/0.01mm
- Zero setting at any position
- Large LCD display
- Inch/Metric conversion at any position
- Indicator bar for travel included
- Single stainless steel beam with light weight construction

- Carbide tipped scriber
- Micro USB data output port
- Auto power off
- Battery: 3V CR2032 included
- Supplied in protective case



Micro USB
Data Output

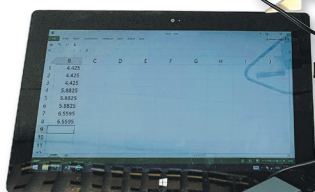

Computer not included



Item #	Description
35-630	Mini Digital Height Gauge
35-WL-MC	Mini Digital Height Gauge w/Micro USB Data Kit
35-630-USB	Micro USB Data Kit

IP54 MINI DIGITAL HEIGHT GAUGES

0 - 6"/150 MM MEASURING RANGE

- IP54 protective rating: Moisture and dust resistance
- 35-629 has absolute encoding technology Memorize absolute origin zero
- Accuracy: 0.001"/0.03 mm
- Large LCD display
- Hold function
- Single stainless steel beam with light weight construction
- Aluminum base with strong magnets
- Auto shut off after 5 minutes
- Micro USB data output port
- Battery: 3V CR2032 included
- Supplied in protective case

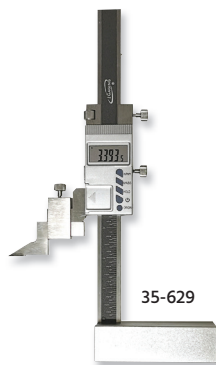

Item #	Color	Scriber	Resolution
35-628	Silver	Fixed	0.0005"/0.01 mm/ 1/128"
35-641*	Black	Fixed	0.0005"/0.01 mm/ 1/64"
35-629	Silver	Attachable	0.0005"/0.01 mm/ 1/128"
35-628-USB	Micro USB Data Kit		

Micro USB
Data Output



*Special order

3-IN-1 DIGITAL ROUTER DEPTH/ CENTER GAUGE/HEIGHT GAUGE

0 - 5" / 125 MM MEASURING RANGE

- Resolution: 0.0005"/0.01 mm / 1/64"
- Accuracy: 0.0015"/0.03 mm
- Large LCD display
- 1/4", 3/8" and 1/2" shank center step
- 1/4" hardened scriber
- Indicator bar for travel included
- Single stainless steel beam with light weight construction
- Anodized aluminum base with strong magnets
- Battery: 3V CR2032 included

PATENT Pending



Item # 35-648



35-ZA88

iGAGING
EXCLUSIVE

IP66

**MAGNETIC
BASE**

IP66 ELECTRONIC DIGITAL TOOL SETTING GAUGE

- IP66 protective rating:
Dust and high pressure water jets resistance
- Easy to read SUPER LARGE LCD display
- Backlit Alert when calibration to zero
- Inch/Metric conversion
- Resolution: 0.00005"/0.001 mm
- Accuracy: ± 0.00015 "/0.003 mm
- Repeatability: ± 0.00015 "/0.003 mm
- Steel contact surface with 0.0002" flatness
- 5 magnets on base
- Default setting height 2"
- Battery: 3V CR2032 included
- Supplied in protective case

Item # 35-ZA88

PRECISION DIGITAL DUROMETERS

SHORE A & D

- Ergonomic and lightweight design
- Measure range: 0 - 100 HSA/HSD
- Resolution: 0.5 H
- Deviation: <1%H
- Accuracy: ± 2 HSA/HSD
- Battery: 3V CR2032 included
- Supplied in protective case
- Hardness test calibration set available



35-HA-100

Item # Description

35-HA-100 Shore A Digital Durometer
35-HD-100 Shore D Digital Durometer

IP54 ABSOLUTE TRI-POINT DIGITAL INTERNAL BORE GAUGES

WITH HAND GRIP FOR SMOOTH HANDLING

NEW

ORIGIN ABSOLUTE
SERIES



- IP54 protective rating: Moisture and dust resistance
- Absolute encoding technology: Memorize absolute origin zero
- 330° display rotation
- Large LCD display
- Inch/Metric conversion
- Reading: 0.00005"
- Contact points are designed to allow measurements near the bottom of blind holes
- Carbide Measuring surfaces
- SPC/USB data output
- Setting ring and wrench included
- 4" & 6" Extension rods available.
- Battery: 3V CR2032 included
- Supplied in protective case



35-DB-160



Side View



Item #	Range	Accuracy	Setting Ring
35-DB-100	0.8 - 1.0"/20 - 25 mm	0.00015"/0.004 mm	0.9843"
35-DB-120	1.0 - 1.2"/25 - 30 mm	0.00015"/0.004 mm	0.9843"
35-DB-160	1.2 - 1.6"/30 - 40 mm	0.00015"/0.004 mm	1.5748"
35-DB-200	1.6 - 2.0"/40 - 50 mm	0.0002"/0.005 mm	1.5748"
35-DB-250	2.0 - 2.5"/50 - 63 mm	0.0002"/0.005 mm	2.4409"
35-DB-300	2.5 - 3.0"/62 - 75 mm	0.0002"/0.005 mm	2.4409"
35-DB-350	3.0 - 3.5"/75 - 88 mm	0.0002"/0.005 mm	3.4252"
35-DB-400	3.5 - 4.0"/87 - 100 mm	0.0002"/0.005 mm	3.4252"
35-DB-500	4.0 - 5.0"/100 - 125 mm	0.0002"/0.005 mm	3.4252"
35-DB-600	5.0 - 6.0"/125 - 150 mm	0.0002"/0.005 mm	3.4252"
35-700-USB	SPC/USB Cable Data Kit		
35-WL-CAD	Wireless Data Output Kit		
35-BT-28	Smart Wireless Data Output Kit		

IP54 TRI-POINT PISTOL GRIP INTERNAL MICROMETERS & SET

PATENT Pending

NEW



Micro USB
Data Output



35-3PG-120

- IP54 protective rating:
Moisture and dust resistance
- Absolute encoding technology
Memorize absolute origin zero
- 90° display rotation
- Large LCD display
- Inch/Metric conversion
- Reading: 0.00005"
- Contact points are designed to allow measurements near the bottom of blind holes
- Carbide Measuring surfaces
- Micro USB data output
- Setting ring and wrench included
- 4" & 6" Extension rods available.
- Battery: 3V CR2032 included
- Supplied in protective case

Item #	Range	Accuracy	Setting Ring
35-PG3-035	0.275 - 0.35"/6 - 8 mm	0.00015"/0.004 mm	0.3150"
35-PG3-042	0.35 - 0.425"/8 - 10 mm	0.00015"/0.004 mm	0.3150"
35-PG3-050	0.425 - 0.5"/10 - 12 mm	0.00015"/0.004 mm	0.4724"
35-PG3-065	0.5 - 0.65"/12 - 16 mm	0.00015"/0.004 mm	0.6299"
35-PG3-080	0.65 - 0.8"/16 - 20 mm	0.00015"/0.004 mm	0.6299"
35-PG3-100	0.8 - 1.0"/20 - 25 mm	0.00015"/0.004 mm	0.9843"
35-PG3-120	1.0 - 1.2"/25 - 30 mm	0.00015"/0.004 mm	0.9843"
35-PG3-160	1.2 - 1.6"/30 - 40 mm	0.00015"/0.004 mm	1.5748"
35-PG3-200	1.6 - 2.0"/40 - 50 mm	0.0002"/0.005 mm	1.5748"
35-PG3-200-4	4 Pc. Set: 0.8 - 2"/20 - 50mm Set Includes one setting ring & wrench in fitted case		
35-PG3-250	2.0 - 2.5"/50 - 63 mm	0.0002"/0.005 mm	2.4409"
35-PG3-300	2.5 - 3.0"/62 - 75 mm	0.0002"/0.005 mm	2.4409"
35-PG3-350	3.0 - 3.5"/75 - 88 mm	0.0002"/0.005 mm	3.4252"
35-PG3-400	3.5 - 4.0"/87 - 100 mm	0.0002"/0.005 mm	3.4252"
35-PG3-400-4	4 Pc. Set: 2.0 - 4.0"/50 - 100 mm Includes one setting ring & wrench in fitted case		
35-PG3-500	4.0 - 5.0"/100 - 125 mm	0.0002"/0.005 mm	3.1496"
35-PG3-600	5.0 - 6.0"/125 - 150 mm	0.0002"/0.005 mm	3.5433"
35-630-USB	SPC/USB Cable Data Kit		
35-WL-MC	Wireless Data Output Kit		
35-BT-MC	Smart Wireless Data Output Kit		

IP54 TRI-POINT DIGITAL INTERNAL BORE GAUGE/MICROMETER SET



**iGAGING[®]
EXCLUSIVE**



35-3PT-3040

PATENT Pending

1.0358 in
INCH

31.75 mm
METRIC

SPC Data Output



Computers not included

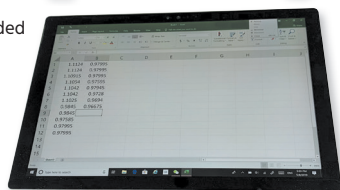

35-3PT-2025

Shown w/USB Data Output Kit
and Wireless Output Kit



- IP54 protective rating: Moisture and dust resistance
- X-Large LCD display
- Inch/Metric conversion
- Resolution: 0.00005"/0.001 mm
- Contact points are designed to allow measurements near the bottom of blind holes

- Carbide Measuring surfaces
- Friction thimble
- SPC/USB data output
- Setting ring and wrench included
- Battery: 3V CR2032 included
- Supplied in protective case

Item #	Range (Inch)	Range (Metric)	Setting Ring	Tolerance
35-3PT-0608	0.236 - 0.315"	6 - 8 mm	0.3150"	0.00016"
35-3PT-0810	0.315 - 0.394"	8 - 10 mm	0.3150"	0.00016"
35-3PT-1012	0.394 - 0.472"	10 - 12 mm	0.3937"	0.00016"
35-3PT-1216	0.472 - 0.65"	12 - 16.51 mm	0.6299"	0.00016"
35-3PT-1620	0.65 - 0.8"	16.51 - 20.32 mm	0.6693"	0.00016"
35-3PT-2025	0.8 - 1.0"	20.32 - 25.40 mm	0.9843"	0.00020"
35-3PT-2530	1.0 - 1.2"	25.40 - 30.48 mm	1.1811"	0.00020"
35-3PT-3040	1.2 - 1.6"	30.48 - 40.64 mm	1.5748"	0.00020"
35-3PT-4050	1.6 - 2.0"	40.64 - 50.80 mm	1.9685"	0.00020"
35-3PT-5060	2.0 - 2.5"	50 - 63 mm	2.3622"	0.00020"
35-3PT-6275	2.5 - 3.0"	62 - 75 mm	2.7559"	0.00020"
35-3PT-7588	3.0 - 3.5"	75 - 88 mm	3.1496"	0.00025"
35-3PT-87100	3.5 - 4.0"	87 - 100 mm	3.5433"	0.00025"
100-700-USB	SPC/USB Cable Data Kit			
35-WL-CAD	Wireless Output Kit			
35-BT28	Smart Wireless Kit			

EXTENDED INTERNAL BORE GAUGE SETS

0.7 - 6" MEASURING RANGE

- Close tolerance inspection of bores for size, roundness, ovality and taper



35-2868-i



34-6868



ORIGIN ABSOLUTE
SERIES



35-2603



SPC
Data Output

SETS INCLUDE:

- 3 interchangeable measuring heads: 0.7" - 1.5", 1.5" - 2" & 2" - 6"
- 3 sets of anvils with carbide points: 0.7, 0.8, 0.9, 1.0, 1.1, 1.2, 1.3, 1.4", 1.4, 1.6, 1.8, 2", 2.0, 2.2, 2.4, 2.8, 3.0, 3.2, 3.4, 3.6, 3.8, 4"
- 2" extender
- 3 spacers/washers: 0.02, 0.05, 0.1"
- Supplied in protective case

IP54 ABSOLUTE

ELECTRONIC INDICATOR

- IP54 protective rating: Moisture and dust resistance
- Range: 0 - 0.5"/12.7 mm
- Resolution: 0.00005"/0.001 mm
- SPC/USB data output

ELECTRONIC INDICATOR

- Range: 0 - 0.25"/6.85 mm
- Resolution: 0.0001"/0.001 mm

DIAL INDICATOR*

- Range: 0 - 0.25"
- Resolution: 0.0005"
- Reading: 0-25-0

* Metric size available

Item #	Description
35-2868-i	iP54 Absolute Electronic Extended Internal Bore Gauge Set
35-2603*	Electronic Extended Internal Bore Gauge Set
34-6868	Dial Extended Internal Bore Gauge Set
100-700-USB	SPC/USB Cable Data Kit
35-WL-CAD	Wireless Output Kit
35-BT28	Smart Wireless Kit

*Special order

EXTENDED INTERNAL DIGITAL BORE GAUGE SETS

1.4 - 6" MEASURING RANGE

- IP54 protective rating: Moisture and dust resistance
- Close tolerance inspection of bores for size, roundness, ovality and taper

SETS INCLUDE:

- 2 interchangeable measuring heads: 1.4" - 2" & 2" - 6"
- 2 sets of anvils with carbide points: 1.4, 1.6, 1.8, 2", 2.0, 2.2, 2.4, 2.8, 3.0, 3.2, 3.4, 3.6, 3.8, 4"
- 2" extender
- 3 spacers/washers: 0.02, 0.05, 0.1"
- Supplied in protective case

ORIGIN ABSOLUTE
SERIES



35-280-i



IP54 ABSOLUTE ELECTRONIC INDICATOR

- IP54 protective rating: Moisture and dust resistance
- Range: 0 - 0.5"/12.7 mm
- Resolution: 0.00005"/0.001 mm
- SPC/USB data output

ELECTRONIC INDICATOR

- Range: 0 - 0.25"/6.85 mm
- Resolution: 0.0001"/0.002 mm

DIAL INDICATOR

- Range: 0 - 0.25"
- Resolution: 0.0005"
- Reading: 0-25-0
- * Metric size available



SPC
Data Output

Item #	Description
35-280-i	iP54 Absolute Electronic Extended Internal Bore Gauge Set
35-2602*	Electronic Extended Internal Bore Gauge Set
34-668	Dial Extended Internal Bore Gauge Set
100-700-USB	SPC/USB Cable Data Kit
35-WL-CAD	Wireless Output Kit
35-BT28	Smart Wireless Kit

*Special order

INTERNAL DIAL & DIGITAL BORE GAUGE SETS

- Close tolerance inspection of bores for size, roundness, ovality and taper

SETS INCLUDE:

- Set of anvils with carbide points: 2.0, 2.2, 2.4, 2.8, 3.0, 3.2, 3.4, 3.6, 3.8, 4"
- 2" extender
- Supplied in protective case

DIAL INDICATOR

- Range: 0 - 0.25"
- Resolution: 0.0005"
- Reading: 0-25-0



34-626

Item #	Description
34-714	0.4 - 0.7" Internal Dial Bore Gauge Set
34-715	0.7 - 1.5" Internal Dial Bore Gauge Set
34-626	0 - 2.6" Internal Dial Bore Gauge Set
35-260A	0 - 2.6" Internal Digital Bore Gauge Set

BORE GAUGE SETTING MASTER KITS

FOR SETTING UP BORE GAUGE UP TO 6" ACCURATELY

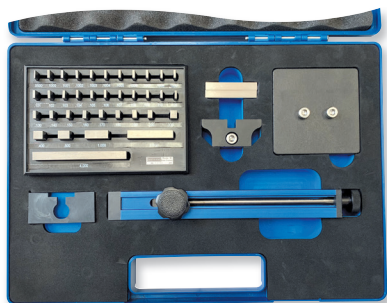

36-036

CERTIFIED



36-036-N

Bore Gauge not included

BORE GAUGE SETTING MASTER:

Internal capacity: 6"
 Depth capacity: 1"
 Centralizer capacity width: 2 5/8"

- 2 Pc. Anvils: 2 5/8" x 3/8"
- Supplied in protective case

36 Pc. GAGE BLOCK SET (36-S36)

1 Block: .050"
 9 Blocks: .1001" - .1009" in .0001" steps
 9 Blocks: .101" - .109" in .001" steps
 9 Blocks: .110" - .190" in .010" steps
 5 Blocks: .100" - .500" in .100" steps
 3 Blocks: 1", 2", 3"
 Certificate of Calibration traceable to NIST

Item #	Description
36-S36	Bore Gauge Setting Master Kit w/Gage Block Set
36-036-N	Bore Gauge Setting Master Kit

MINI & MULTI ADJUSTABLE ROUTER DEPTH & CENTER GAUGES & SET

PATENT Pending

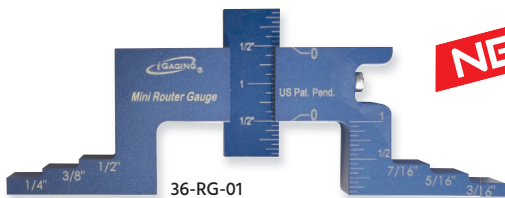

36-RG-01

NEW

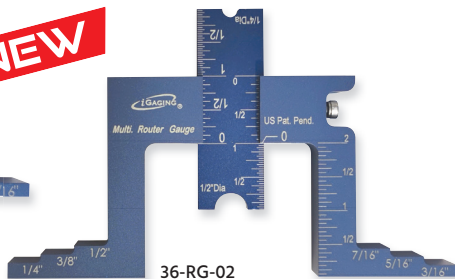

36-RG-02

- 1" Mini Depth & Center Gauge (36-RT01):
 has a 64th scale, 3/16, 1/4, 5/16, 3/8, 7/16 and 1/2" steps
- 2" Multi Depth & Center Gauge (36-RT02):
 has a 64th and 32nd scale, 3/16, 1/4, 5/16, 3/8, 7/16 and 1/2" steps, 1/4" and 1/2" diameter shank center check

- Aluminum body with blue anodized finish
- Laser engraving markings
- Supplied in protective case

Item #	Description
36-RG-01	1" Mini Adjustable Router Depth & Center Gauge
36-RG-02	2" Multi Adjustable Router Depth & Center Gauge
36-RG-22	1" & 2" Mini & Multi Adjustable Router Depth & Center Gauge Set

GAGE BLOCK SETS

INCH & METRIC

- Manufactured to meet NIST Federal Specification ASME B89.1.9 - 2002 tolerances on length for inch gage blocks.
- Certificate of Calibration traceable to NIST
- Tolerances to $\pm .00005$ "
- Supplied in protective case



36-036-0

CERTIFIED



36-081-0

36 PC. GAGE BLOCK SETS

- 1 Block: .050"
- 9 Blocks: .1001" - .1009" in .0001" steps
- 9 Blocks: .101" - .109" in .001" steps
- 9 Blocks: .110" - .190" in .010" steps
- 5 Blocks: .100" - .500" in .100" steps
- 3 Blocks: 1", 2", 3"

Item #	Grade	Description
36-036-0	0	36 Pc. Gage Block Set
36-036-B	Shop	36 Pc. Gage Block Set

81 PC. GAGE BLOCK SETS

- 9 Blocks: .1001" - .1009" in .0001" steps
- 49 Blocks: .101" - .149" in .001" steps
- 19 Blocks: .050" - .950" in .050" steps
- 4 Blocks: 1.000" - 4.000" in 1.000" steps

Item #	Grade	Description
36-081-0	0	81 Pc. Gage Block Set
36-081-B	Shop	81 Pc. Gage Block Set

47 PC. METRIC GAGE BLOCK SETS - GRADE 0

- 1 Block: 1.005 mm
- 9 Blocks: 20 - 100 mm in 10 mm steps
- 10 Blocks: 1 - 10mm in 1 mm steps
- 8 Blocks: 1.2 - 1.9 mm in .1 mm steps
- 19 Blocks: 1.01 - 1.19 mm in .01 mm steps

87 PC. METRIC GAGE BLOCK SETS - GRADE 0

- 2 Block: 0.5 mm to 1.00 mm
- 9 Blocks: 1.001 - 1.009 mm in .001 mm steps
- 50 Blocks: 1.01 - 1.50 mm in .01 mm steps
- 17 Blocks: 2 - 10 mm in .5 mm steps
- 9 Blocks: 20 - 100 mm in 10 mm steps

Item #	Description
36-47-M-0	47 Pc. Metric Gage Block Set
36-87-M-0	87 Pc. Metric Gage Block Set

11 PC. GAGE BLOCKS & OPTICAL SET

GRADE AS-0

- Manufactured to meet NIST Federal Specification ASME B89.1.9 - 2002 tolerances on length for inch gage blocks.
- 9 Rectangular Blocks: .0625, .100, .125, .200, .250, .300, .500, 1.000 & 2.000"
- 2 Optical Flats: vary in size by .0125" which allows checking anvil faces at half rotations of spindle for measuring flatness.
- Certificate of Calibration traceable to NIST
- Supplied in high quality wooden case



36-9162

Item # 36-9162

CERTIFIED

IP54 ABSOLUTE DRO

DIGITAL SCALES W/REMOTE READOUT

HORIZONTAL OR VERTICAL

PATENTED

iGAGING
EXCLUSIVE

ORIGIN ABSOLUTE
SERIES



- IP54 protective rating: Moisture and dust resistance
- Absolute encoding technology Memorize absolute origin zero
- Ultra-Response measure speed
- Resolution: 0.0005"/0.01 mm/ $\frac{1}{64}$ "
- Absolute/Incremental setting
- On/Off button
- Preset button
- Hold button
- Origin button
- Remote cable length: 76"
- Display has 6 key LCD and magnetic strips in back to allow for easy attachment to steel surfaces.
- Articulating arm allows for stacking multiple displays
- Hardened stainless steel body
- Mounting brackets included
- SPC/USB data output
- Power: 3V CR2032 battery included/ AC power (not included)

Item #	Measurable Range	Accuracy	Distance Between Mounting Brackets
35-806-A	0 - 6"/150 mm	0.001"/0.02 mm	11 1/4"
35-812-A	0 - 12"/300 mm	0.0015"/0.03 mm	17 1/4"
35-824-A	0 - 24"/508 mm	0.002"/0.051 mm	29 1/4"
35-832-A	0 - 32"/800 mm	0.0025"/0.0635 mm	37 1/4"
35-838-A	0 - 38"/950 mm	0.003"/0.076 mm	43 1/4"
35-860-AC	AC Power Supply		
100-700-USB	SPC/USB Cable Data Kit		
100-700-WL	Wireless Data Kit		

EZ VIEW DRO PLUS

DIGITAL SCALES W/REMOTE READOUT

HORIZONTAL OR VERTICAL

iGAGING®
EXCLUSIVE

PATENTED

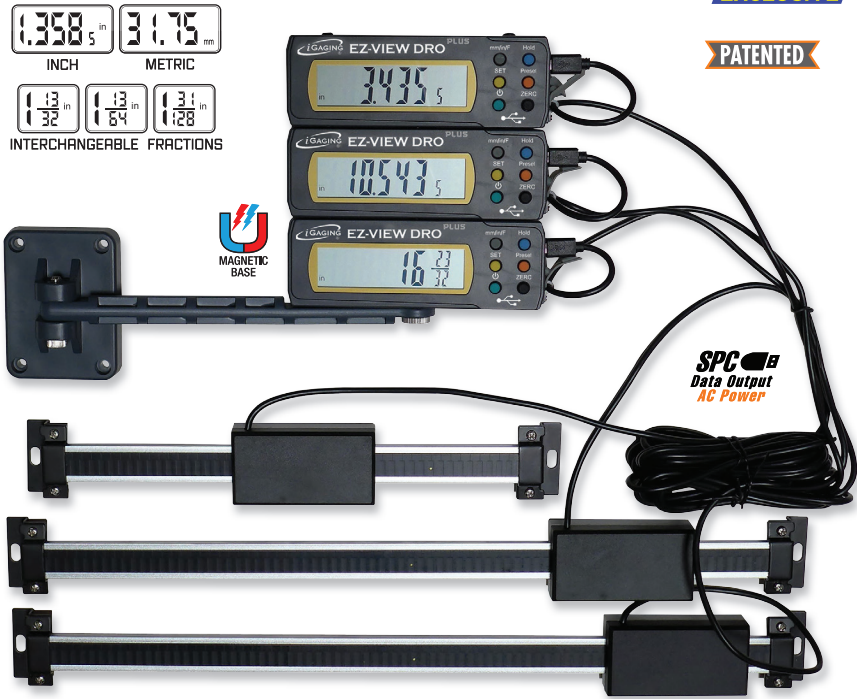

- Resolution: 0.0005"/0.01 mm/ Fraction Interchangeable $\frac{1}{32}$ ", $\frac{1}{64}$ ", $\frac{1}{128}$ "
- On/Off button
- Preset button
- Hold button
- Origin button
- Remote cable length: 76"
- Articulating arm allows for stacking multiple displays
- Display has 6 key LCD and magnetic strips in back to allow for easy attachment to steel surfaces.
- Alloy aluminum body
- Mounting brackets included
- SPC/USB data output
- Power: 3V CR2032 battery included/ AC power (not included)

Item #	Measurable Range	Accuracy	Distance Between Mounting Brackets
35-706-P+	0 - 6"/150 mm	0.0025"/0.06 mm	11 1/4"
35-712-P+	0 - 12"/300 mm	0.0035"/0.08 mm	17 1/4"
35-724-P+	0 - 24"/508 mm	0.004"/0.10 mm	29 1/4"
35-736-P+	0 - 36"/800 mm	0.008"/0.20 mm	41 1/4"
35-860-AC	AC Power Supply		
100-700-USB	SPC/USB Cable Data Kit		
35-WL-CAD	Wireless Data Kit		

IP54 DIGITAL QUILL KIT FOR MILLING MACHINE

VERTICAL SCALE



ORIGIN ABSOLUTE SERIES



- IP54 protective rating: Moisture and dust resistance
- Range: 0 - 6"/125 mm
- Absolute encoding technology
- Memorize absolute origin zero
- Ultra-Response measure speed
- Easy to read LCD display
- Resolution: 0.0005"/0.01 mm/1/64"
- Accuracy: ±0.001"/0.03 mm
- Repeatability: 0.0005"/0.01 mm
- On/Off button
- Absolute/Incremental function
- Preset button
- Zero set button
- Hardened stainless steel body
- Mounting brackets included
- Battery: 3V CR2032 included



35-608-i

Item # 35-608-i

IP54 ELECTRONIC DIGITAL SCALES

HORIZONTAL OR VERTICAL



ORIGIN ABSOLUTE SERIES



35-606-P



- IP54 protective rating: Moisture and dust resistance
- Absolute encoding technology
- Memorize absolute origin zero
- Ultra-Response measure speed
- Easy to read LCD display
- Resolution: 0.0005"/0.01 mm/1/64"
- On/Off button
- Absolute/Incremental function

- Hold button
- Zero set button
- Hardened stainless steel body
- Mounting brackets included
- Battery: 3V CR2032 included

Item #	Range	Accuracy
35-606-P	0 - 6"/150 mm	0.001"/0.02 mm
35-612-P	0 - 12"/300 mm	0.0015"/0.03 mm

IP67 EZ VIEW FENCE DIGITAL READOUT

52" EXTENDED RANGE



35-EF52

- IP67 protective rating:
Water and coolant proof
- Measuring range: 0 - 52"/1320 mm
- LCD display
- Resolution: 0.0005"/0.01 mm / 1/64"
- Accuracy: 0.003"/0.08 mm @ full 52"
- On/Off button
- Easy to use calibration and preset functions
- Accessories included:
 - Mounting brackets
 - .2 mm adhesive beam
 - Inch/Metric adhesive rule
 - Installation instructions
 - Micro USB data cable for recharging
- Battery: 3V CR2032 included
80" AC power cable



Item # 35-EF52

IP54 EZ PLANNER PRECISION DRO

FOR DEWALT PLANERS



35-607



Planer not included



PATENT Pending

- IP54 protective rating:
Moisture and dust resistance
- EZ View: 3-way reading large display
- EZ Calibration: simple to setup and use preset value
- EZ Installation: effortless setup for common brand planers (parts and instructions included)
- EZ Display: easy to read large backlit LCD display
- EZ Power: 3V CR2032/Micro USB AC power included

- Measuring range: 0 - 6"
- Resolution: 0.0005"/0.01 mm / 1/64"
- Accuracy: ±0.001"/0.03 mm
- On/Off button
- Auto turn off after 5 minutes without use, but will return to the previous reading with a touch of a button.
- Hardened stainless steel scale
- Mounting brackets included

Item # 35-607

IP65 ABSOLUTE 6" TORPEDO LEVEL

WITH OR WITHOUT SMART WIRELESS DATA OUTPUT



- IP65 protective rating: Coolants, grit and dust proof
- Standard backlit display for easy viewing
- V-grooves on top and bottom for curved surfaces
- Strong magnetic base
- Digital level sensor
- Precision lapping
- Anodized finish
- Alloy constructed and CNC machined body
- Micro USB data output port for recharging and data output
- Supplied in protective case
- Smart Wireless Data Output connects to Bluetooth device



35-2366



35-2377



Micro USB
Data Output

SPECIFICATIONS:

- Tilt range: 0 - 90° x 4
- Resolution: 0.05°
- Accuracy: ±0.2°
- Repeatability: 0.1°
- Size: 6" x 2.4" x 1.2"
- Weight: 8 oz.



Item #	Description
35-2377	iP65 Absolute Torpedo Level w/Smart Wireless
35-2366	iP65 Absolute Torpedo Level
35-2268-USB	Micro USB Data Kit

eLEVEL PRECISION DIGITAL LASER LEVELS

2-IN-1 DIGITAL LEVEL AND BEVEL GAUGE



SPECIFICATIONS:

- Measuring: 0 - 90 x 4
- Resolution: 0.05°
- Accuracy: ±0.2°
- Battery: 9V included



35-909-L



35-948-L

- CNC machined super flat surfaces and edges
- Cross hair laser level accurately extend level capabilities
- Large clear LCD display, reversible reading
- Two vials read plum and level.
- Heavy duty aluminum alloy body, chrome finish
- Strong magnets on the bottom
- 1/4 inch thread standard tripod mounting
- Bevel function: set up any surface as relative zero degree surface
- Supplied with a soft cloth carry bag

Item #	Description
35-909-L	9" eLevel Precision Digital Laser Level
35-924-L	24" eLevel Precision Digital Laser Level
35-948-L	48" eLevel Precision Digital Laser Level



IP54 ANGLECUBE® ANGLE GAUGES

WITH OR WITHOUT SMART WIRELESS DATA OUTPUT



35-2268



35-2269



35-2270



SPECIFICATIONS:

- Tilt range: 0 - 90° x 4
- Resolution: 0.05°
- Accuracy: ±0.2°
- Repeatability: 0.1°
- Size: 2.13" x 2.13" x 0.19"
- Weight: 2.7 oz.
- IP54 protective rating: Moisture and dust resistance
- Standard backlit display for easy viewing (Item #'s 35-2270 & 35-2269)
- Magnetics on bottom and 2 sides
- Precision digital level sensor
- Anodized finish
- Alloy aluminum body
- Micro USB data output port (Cable for charging or data output option included)
- Supplied with a protective pouch
- Smart Wireless Data Output connects to Bluetooth device

Item #	Description
35-2270	AngleCube® Angle Gauge w/Smart Wireless & Backlit
35-2269	AngleCube® Angle Gauge w/Backlit
35-2268	AngleCube® Angle Gauge
35-2268-USB	Micro USB Data Kit

Micro USB
Data Output



Rechargeable
Battery

ANGLECUBE® ANGLE GAUGES

SPECIFICATIONS:

- Measuring range: 360° (4 x 90)
- Resolution: 0.05°
- Accuracy: ±0.2°
- Repeatability: 0.1°
- Size: 2.13" x 2.13" x 0.91"
- Weight: 2.7 oz.
- Tilt % and backlit display (35-222-9)
- Magnetics on bottom and 2 sides
- Precision digital level sensor
- Anodized finish
- Alloy aluminum body
- Battery: 9V included
- Supplied with a protective pouch



35-222-6

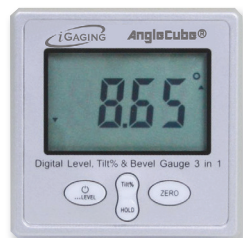

35-222-9



Item #	Description
35-222-6	AngleCube® Angle Gauge
35-222-9	AngleCube® Angle Gauge w/Tilt % & Backlit

ELECTRONIC DIGITAL ANGLE PROTRACTORS

SPECIFICATIONS:

Measuring range: 0 - 360°
 Resolution: 0.05°
 Accuracy: ±0.2°
 Repeatability: 0.05°
 Battery: 3V CR2032 included

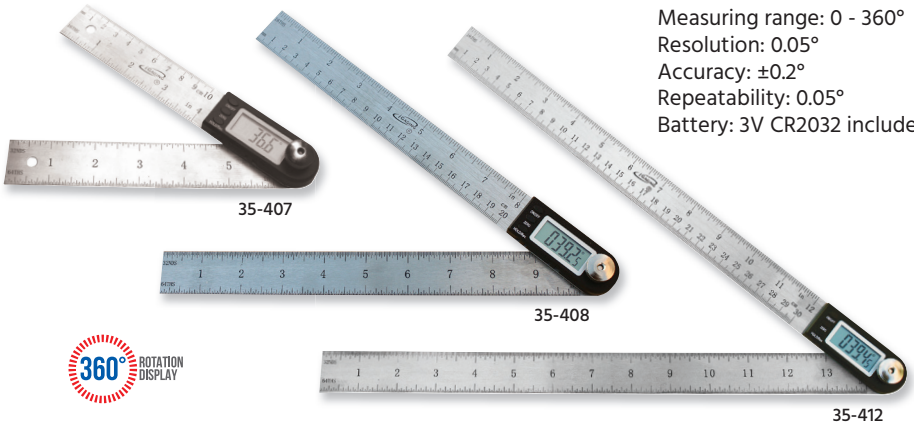

- Stainless steel rule blades with inch and metric marking scales
- Scale readings: $\frac{1}{16}$ " , $\frac{1}{32}$ " , $\frac{1}{64}$ " , mm
- Strong metal locking nut
- Large LCD digital displays in degrees
- Reversible reading
- Hold function
- Inside and outside angle measurements
- Auto shut-off
- Supplied in protective case

Item #	Blade Size	
	Top	Bottom
35-407	4"	7"
35-408	8"	10"
35-412	12"	14"
35-418	18"	20"

ELECTRONIC DIGITAL GONIOMETER

SPECIFICATIONS:

Measuring range: 0 - 360°
 Resolution: 0.05°
 Accuracy: ±0.2°
 Repeatability: 0.05°
 Battery: 3V CR2032 included

- 2 transparent Poly-Carbonate blades with 8" and 10" rules
- Scale readings: $\frac{1}{16}$ " , mm
- Strong locking nut
- Large LCD digital displays in degrees
- Reversible reading
- Hold function
- Inside and outside angle measurements
- Display reads continuously as arms are adjusted



** Not available in all markets

Item # 35-310

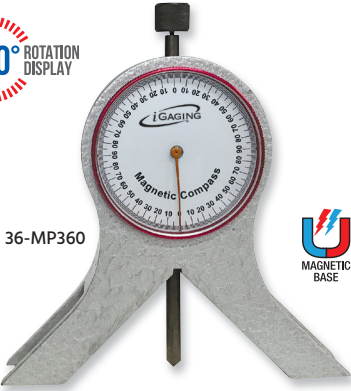

36-MP360



360° MAGNETIC DIAL PROTRACTOR WITH CENTER PUNCH

- Strong magnetic strip on the legs & base
- 3.2" V-opening/1.4" depth
- Best for piping and cylinder objects
- Heavy duty center punch
- Steel construction body

Item # 36-MP360

DIGITAL T-BEVEL & ANGLE PROTRACTORS

SPECIFICATIONS:

Measuring range: 0 - 180°
 Accuracy: $\pm 0.2^\circ$
 Battery: 3V CR2032 included

- Solid stainless steel body
- Strong locking knob
- Large LCD digital displays in degrees
- Reversible reading
- Hold function
- Smooth movement



35-T0506



Item #	T-Bar Size	Blade Length
35-T0506	5"/125 mm	6"/150 mm
35-T0608	6"/150 mm	8"/200 mm
35-T0812	8"/200 mm	12"/300 mm
35-T1224	12"/300 mm	24"/600 mm

ELECTRONIC MAGNETIC DIGITAL ANGLE PROTRACTORS

** Not available in all markets



35-012

SPECIFICATIONS:

Measuring range: 0 - 360°
 Resolution: 0.05°
 Accuracy: $\pm 0.2^\circ$
 Battery: 3V CR2032 included



- Magnetic alloy blades
- Strong locking nut
- Large LCD digital displays in degrees
- Reversible reading
- Hold function
- Easy zero setting

Item #	Blade Size	
	Top	Bottom
35-004	4"	7"
35-008	8"	10"
35-012	10"	12"

MANUAL PROTRACTORS



34-370

6" SLIDING BEVEL SQUARE

- Perfect for making angles and transferring layout lines
- Strong locking knob
- Stainless steel body
- Supplied in protective vinyl sleeve

Item # 34-370



36-618

PROTRACTOR & DEPTH GAUGE

- Etched graduations from 0 to 180° reads in both directions
- 6" rule is graduated in $\frac{1}{32}$ " increments
- Head Size: $3 \frac{3}{8}$ " w x 2" h
- Strong locking knob
- Supplied in protective vinyl sleeve

Item # 36-618

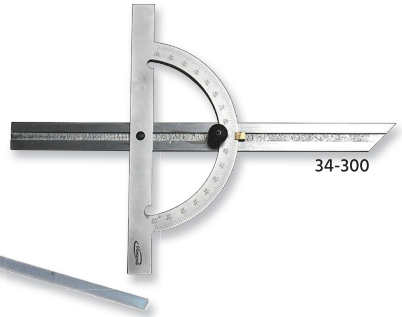

34-300

HARDENED STEEL PROTRACTOR ANGLE FINDER SLIDING BEVEL GAUGE

- Measures up to 170° in both directions 12" long blade and 8" rotating head
- Strong locking knob
- Made from hardened steel
- Supplied in protective vinyl sleeve

Item # 34-300

2-IN-1 DIGICOMPASS & DIVIDER

USE TO SCRIBE PERFECT CIRCLES, ARCS, OR STEPPING OUT EQUAL DISTANCES



35-CD16



35-CD28

- Easy-to-turn center wheel helps you make highly accurate measurements
- Large LCD display
- Inch/Metric/Fraction conversion at any point
- Ease to switch from divider to compass mode
- Hold and Zero Set Functions
- Interchangeable pencil leads and metal scribe attachments included

- Chrome finish
- Alloy or Poly-fiber jaws
- Battery 3V CR2032 included
- Supplied in protective case

Item #	Material	Measuring Range	
		Radius	Diameter
35-CD16	Poly	0 - 6"	0 - 12"
35-CD26	Poly	0 - 8"	0 - 16"
35-CD28	Alloy Jaws	0 - 8"	0 - 16"

PROTRACTORS

RECTANGULAR & HALF-ROUND

- Measures angle from 0 - 180° in both directions
- Graduation: 1°
- Accuracy: $\pm 0.5^\circ$
- 6" beam
- Strong locking handle
- Made of stainless steel
- Satin chrome finish
- Supplied in protective pouch

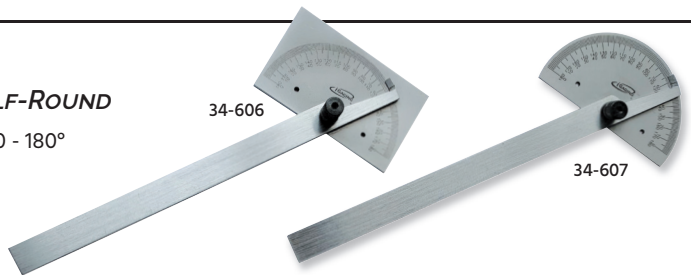

Item #	Description
34-606	Rectangular Protractor Head
34-607	Half-Round Protractor Head

HEAVY DUTY CENTER GAUGES

- Used to accurately and efficiently find the center of both round and square objects
- 90° right angle head with a graduated rule precisely set at a 45° angle to the center of the right angle.
- Scale rule: $\frac{1}{64}$ "
- Hardened stainless steel
- Satin chrome finish
- Supplied in protective case

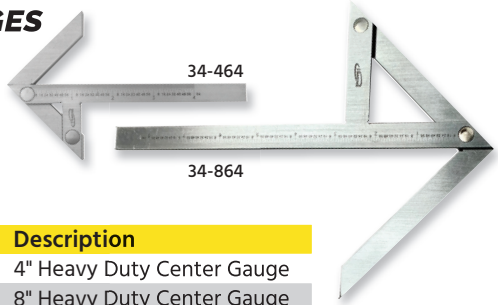

Item #	Description
34-464	4" Heavy Duty Center Gauge
34-864	8" Heavy Duty Center Gauge

ADJUSTABLE DOUBLE SQUARES & SETS

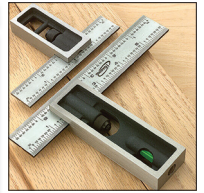

- Accuracy meets Federal Specifications
- Hardened chrome plate blades with scratching protection & smooth slide movement
- Precision lapping on all measuring surfaces
- Base Length:
 - 4" square has 2 $\frac{1}{2}$ "
 - 6"/150 mm squares are 3 $\frac{3}{4}$ " with a vial level

- Sets supplied in protective case
- Graduations:
 - 4R: 8ths, 16ths, 32nds, 64ths
 - M: 1 mm, $\frac{1}{2}$ mm, 1 mm, $\frac{1}{2}$ mm
 - E/M: 1 mm, 64ths, 32nds, $\frac{1}{2}$ mm

ADJUSTABLE DOUBLE SQUARES

Item #	Blade Length	Graduation
34-244-S	4"	4R
34-244-M	100 mm	M
34-244-EM	4"/100 mm	EM
34-266-S	6"	4R
34-266-M	150 mm	M
34-266-EM	6"/150 mm	EM

ADJUSTABLE DOUBLE SQUARE SETS

Item #	Blade Length	Graduation
34-4466	4" & 6"	4R
34-4466-M	100 & 150 mm	M
34-4466-EM	4" & 6" 100 & 150 mm	EM

REPLACEMENT CLAMP SCREWS

Item #	Description
34-244-L	4" Clamp Screw
34-266-L	6" Clamp Screw

360° DIAL PROTRACTORS SETS

- Rust resistant hardened stainless steel
- Strong and rigid locking clamps
- Supplied in protective case



UNIVERSAL BEVEL PROTRACTOR

- Clockwise or counter clockwise readings
- 10° markings in dial window
- Accuracy: ± 5 arc minutes
- Dial Graduation: 1°
- Vernier graduation: 5 minutes
- 6" and 12" blades included



DIAL READING BEVEL PROTRACTOR

- Magnifier for easier and accurate reading
- Dial Graduation: 1°
- Vernier graduation: 5 minutes
- 6" and 12" blades included

Item #	Description
36-612	Universal Bevel Protractor
36-777	Dial Reading Bevel Protractor

ELECTRONIC DIGITAL COMBINATION SQUARE SETS

NEW

iGAGING EXCLUSIVE

PATENT Pending



- Protractor scale range: 0 - 180°
- Reading: 0.05"
- Accuracy: 0.2"
- Squareness: 0.001" per inch
- Hold and flip reading function
- Reverse reading function
- Hardened chrome plate blades with scratching protection & smooth slide movement
- Square head has a vial level and metal scriber

- Lockings lever to lock the angle protractor and the blade from movement
- Auto shut off
- Battery 3V CR2032 included
- Sets supplied in protective case
- Graduations:
 - 4R: 8ths, 16ths, 32nds, 64ths
 - M: 1 mm, 1/2 mm, 1 mm, 1/2 mm
 - E/M: 1 mm, 64ths, 32nds, 1/2 mm

2 PC. SETS - DIGITAL PROTRACTOR & BLADE

Item #	Blade	
	Length	Graduation
35-212-2EM	12"	EM
35-212-2E	12"	4R

4 PC. SETS - SQUARE HEAD, CENTER HEAD, DIGITAL PROTRACTOR & BLADE

Item #	Blade	
	Length	Graduation
35-212-4EM	12"	EM
35-212-4E	12"	4R

COMBINATION SQUARE SETS

QUALITY
BUILT



34-206-3

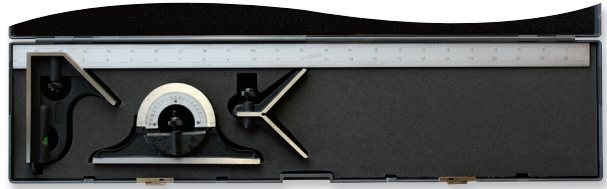

34-224-4



34-212-4



34-212-26

- Accuracy meets Federal Specifications
- Hardened chrome plate blades with scratching protection & smooth slide movement
- Precision lapping on all measuring surfaces
- Square head has a vial level and metal scriber
- Protractor scale graduated from 0 - 180° in both directions
- Sets supplied in protective case
- Graduations:
 4R: 8ths, 16ths, 32nds, 64ths
 M: 1 mm, ½ mm, 1 mm, ½ mm
 E/M: 1 mm, 64ths, 32nds, ½ mm

2 PC. SETS - SQUARE HEAD & BLADE

Item #	Blade Length	Graduation
34-206-2	6"	4R
34-212-2	12"	4R
34-212-2EM	12"/300 mm	EM
34-218-2	18"	4R
34-224-2	24"	4R
34-212-2M	300 mm	M

3 PC. SETS -

SQUARE HEAD, CENTER HEAD & BLADE

Item #	Blade Length	Graduation
34-206-3	6"	4R

4 PC. SETS - SQUARE HEAD, CENTER HEAD, PROTRACTOR & BLADE

Item #	Blade Length	Graduation
34-212-4	12"	4R
34-212-4EM	12"/300 mm	4R
34-218-4	18"	4R
34-224-4	24"	4R
34-212-4M	300 mm	EM

COMBINATION SQUARE ACCESSORIES

Item #	Size	Head Type
34-212-S	12", 18" & 24"	Square
34-206-C	6"	Center
34-212-C	12", 18" & 24"	Center
34-212-P	12", 18" & 24"	Non-Reversible Protractor

REPLACEMENT BLADES

Item #	Blade Length	Graduation
34-212-B	12"	4R
34-212-BM	300 mm	M
34-212-BEM	12"/300 mm	EM
34-224-B	24"	4R

REPLACEMENT CLAMP SCREWS

Item #	Description
34-206-L	6" Clamp Screw
34-212-L	12", 18" & 24" Clamp Screw

ADJUSTABLE HOOKED RULES

4R GRADUATIONS- 8THS, 16THS, 32NDS, 64THS



34-006-H



- Calibrations are on both sides
- $\frac{1}{8}$ " and $\frac{1}{16}$ " increments on one side, $\frac{1}{32}$ " and $\frac{1}{64}$ " on the other side
- Adjustable hook may be used on both sides
- High-quality machined edges
- Precision etched for long life and readability
- Hardened and tempered stainless steel construction
- Satin chrome finish
- Supplied in protective vinyl pouch

Item #	Description
34-006-H	6" Hooked Rule
34-012-H	12" Hooked Rule
34-018-H	18" Hooked Rule

STEEL RULES

- Laser-engraved markings for easy reading
- 4R Scale-Inch $\frac{1}{8}$ " and $\frac{1}{16}$ " increments on one side, $\frac{1}{32}$ " and $\frac{1}{64}$ " on the other side
- EM Scale-Inch/Metric 0.5 mm and 1 mm increments on one side, $\frac{1}{32}$ " and $\frac{1}{64}$ " increments on the other side
- Hardened stainless steel, with ground edges and a satin non-glare finish
- Ruler ends have $\frac{1}{32}$ " markings for use as a height gauge
- Supplied in protective pouch



34-006

Item #	Size	Type
34-006-4R	6"	4R
34-012-4R	12"	4R
34-018-4R	18"	4R
34-024-4R	24"	4R
34-006-N	6"	E/M
34-012-N	12"	E/M
34-006-HM	100 mm	M
34-012-HM	300 mm	M

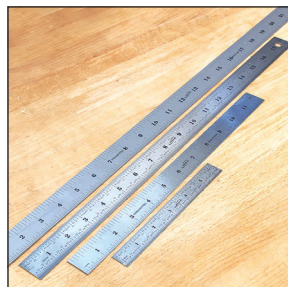

34-ST12

ADJUSTABLE RULE STOP FOR 12", 18" & 24" STEEL RULES

- Ideal for use with steel rules that are up to 1" wide x 0.40" width
- Strong metal locking screw
- Overall size: 1.310" x 0.790" x 0.215"

Item #	34-ST12
--------	---------

PREMIUM MARKING KNIVES

- Double beveled edge blade with a flat back
- Handle length: 5"
- Overall length: 6 1/2"
- Blade is hardened HSS steel
- Solid hardwood handle
- Supplied in a protective pouch



Item #	Description
34-330	1 1/2" L x 5/8" W Blade with 55° Angle
34-360	1.56" L x 0.385" x 0.05" Thickness Blade

CENTER, ANGLE & MARKING RULES

CENTER RULE & ANGLE GAUGE

- Measures inch, metric and angles
- Engraved markings center rules in 16ths (top) and 1 mm (bottom), sides are in 8ths and 32nds
- Angle scales from 0° to 60° in 15° increments with a 22.5° angle
- Center marking hole
- Size: 8" x 3"
- Made of black painted hardened steel

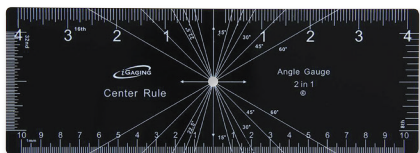

34-C08

12" & 300 MM CENTER FINDER & BEVEL RULES

- Ruler side has a center rule on top in 32nds and Left to right on the bottom in 16ths
- Bevel gauge side has an angle scale from 0° to 50° with 1/2° marks and 1/4° dots for easy reading and a 3" rule on the end.
- Lines and numbers are etched in black
- Size: 12.5" x 3"
- Hardened stainless steel with chrome finish



34-222



34-222-M

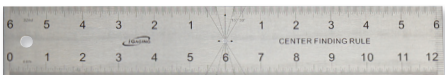

34-C12

12" & 24" CENTER/BEVEL FINDER RULES

- Center finding rule side has a center rule on top in 32nds and Left to right on the bottom in 64ths with 15° and 30° bevel angle markings
- Bevel finding rule side has a center rule on top in 16ths and Left to right on the bottom in 8ths with 22.5°, 45° and 60° bevel angle markings
- 2" height finding gauge on both sides
- Lines and numbers are etched in black
- Hardened stainless steel with chrome finish

Item #	Description
34-C08	Center Rule & Angle Gauge
34-222	12" Center Finder & Bevel Rule
34-222-M	300 mm Center/Bevel Finder Rule
34-C12	12" Center/Bevel Finder Rule
34-C24	24" Center/Bevel Finder Rule

PRECISION ENGINEER & BEVELED SQUARES & SETS



34-246

PRECISION ENGINEER SQUARES & SET

- Accuracy meets DIN 875-1 Specifications
- Hardened steel

Item #	Blade Length	Accuracy	
		Parallel	Square
34-S02	2"	0.0002"	0.0005"
34-S04	4"	0.0002"	0.0005"
34-S06	6"	0.0003"	0.0006"
34-S08	8"	0.0003"	0.0007"
34-S10	10"	0.0004"	0.0008"
34-S12	12"	0.0005"	0.0009"

34-246 3 Pc. Set: 2", 4", 6"

- Accurate right angles for both inside and outside
- Precision lapping for straightness and parallelism
- Supplied in protective case

QUALITY BUILT



34-B246

BEVELED SQUARES & SET

- Beveled blades on both edges of each side
- Accuracy meets DIN 00 Specifications
- Made from a single piece of hardened steel

Item #	Blade Length	Accuracy	
		Parallel	Square
34-B02	2"	0.00008"	0.00012"
34-B03	3"	0.00008"	0.00012"
34-B04	4"	0.00008"	0.00012"
34-B06	6"	0.00012"	0.00016"
34-B08	8"	0.00012"	0.00016"
34-B10	10"	0.00012"	0.0002"

34-B246 3 Pc. Set: 2", 4", 6"

PRECISION STRAIGHT EDGES



36-012-KS

36-024-KS

36-036-KS

- Laser engraved with $\frac{1}{64}$ " or 1 mm graduations on the bevel edge
- Width: $1\frac{9}{16}$ "
- Thickness: $\frac{3}{16}$ "
- Ground and lapped for straightness and parallelism
- Made from hardened and ground steel with satin chrome finish
- Supplied in protective pouch

Item #	Length	Straightness	Parallelism	Squareness
36-012-KS	12"	0.0015"	0.002"	0.003"
36-024-KS	24"	0.0025"	0.003"	0.004"
36-036-KS	36"	0.004"	0.004"	0.005"
36-012-KS-M	300 mm	0.04 mm	0.05 mm	0.075 mm
36-024-KS-M	600 mm	0.06 mm	0.075 mm	0.1 mm
36-036-KS-M	900 mm	0.1 mm	0.1 mm	0.12 mm

iGAGING® EXCLUSIVE

QUALITY BUILT

ULTRA PRECISION KNIFE BLADE STRAIGHT EDGES

- 45° angle
- Height: 1.31"
- Thickness: 0.25"
- Removable isolation grip for better handling and temperature resistance
- Precision lapping for straightness and parallelism
- Made from hardened and ground steel with satin chrome finish
- Supplied in protective case

**QUALITY
BUILT**



36-HKS-06



36-HKS-12

Item #	Length	Straightness
36-HKS-06	6"/150 mm	0.00004"/0.001 mm
36-HKS-12	12"/300 mm	0.00012"/0.003 mm

DIGI-ALIGN ALIGNMENT GAUGE

Precision performance for Table Saw Alignment, Saw Blade Flatness, Fence Alignment, Jointer Knife and Depth of Cut Adjustments

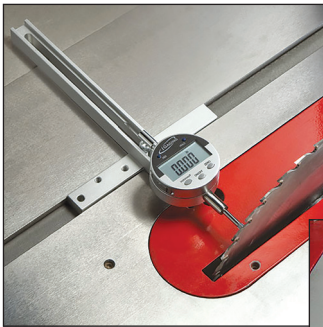

**iGAGING
EXCLUSIVE**



0.358 in 31.75 mm 1 31/128 in
INCH METRIC FRACTION



**MAGNETIC
BASE**

- Measuring range: 4 - 11"
- Gauge measurement range: 0 - 7"
- 6" adjust-to-fit miter slot bar with strong magnets
- 9" slide bar with universal adjustment
- 3 hex head cap screw
- 1 hex wrench

DIGITAL INDICATOR

- Range: 0 - 1"/25 mm
- Reading: 0.0005"/0.01 mm/ 1/128"
- Accuracy: 0.001"
- Repeatability: 0.0005"
- Stem dia.: 3/8"
- Thread size: #4-48
- 3/8" lugback
- Battery: 3V CR2032 included

Item # 35-0928

EZ-ALIGN DIAL INDICATOR ALIGNMENT GAUGE

Precision performance for Table Saw Alignment, Saw Blade Flatness, Fence Alignment, Jointer Knife and Depth of Cut Adjustments

iGAGING[®]
EXCLUSIVE

PREMIUM
BUILT



- Measuring range: 4 - 11"
- Gauge measurement range: 0 - 7"
- 6" adjust-to-fit miter slot bar with strong magnets
- 9" slide bar
- Smooth spring plunger

DIAL INDICATOR

- Range: 0 - 1"
- Stem dia.: $\frac{3}{8}$ "
- Thread size: #4-48
- $\frac{3}{8}$ " lugback
- 3-Way reading dial indicator: 0.001" (outer scale)
 $\frac{1}{64}$ " (middle)
0.1 (inner)



34-0928



10 YEARS OF
EXCELLENCE
EDITION

Item # 34-0928

IP54 DIGITAL SNAP-CHECK GAUGE PLUS

Precision height and depth setups for Table Saws, Router Tables, Surface Planers & Spindle Moulders

iGAGING[®]
EXCLUSIVE

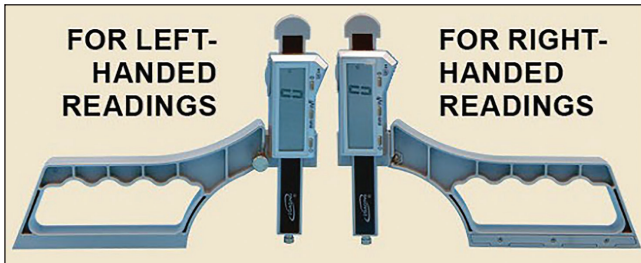

FOR LEFT-
HANDED
READINGS

FOR RIGHT-
HANDED
READINGS



← LEFT
OR RIGHT
SWITCH →



- IP54 protective rating: Moisture and dust resistance
- Measuring Range: 0 - 2" height
0 - $\frac{1}{4}$ " depth
- Reading: 0.0005", 0.01 mm, $\frac{1}{64}$ "
- Accuracy: ± 0.001 "
- Thread size: #4 - 48
- Large clear LCD display
- Spring-loaded plunger
- Strong magnet base
- Display can be switched for right and left handed use
- Ball and Flat tip anvils included
- Auto shut-off
- Battery: 3V CR2032 included

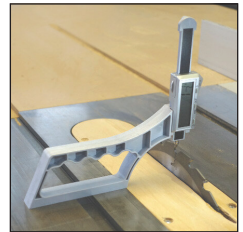

Item # 35-0907

SNAP-CHECK PRO

Precision height and depth setups for Table Saws, Router Tables, Surface Planers & Spindle Moulders

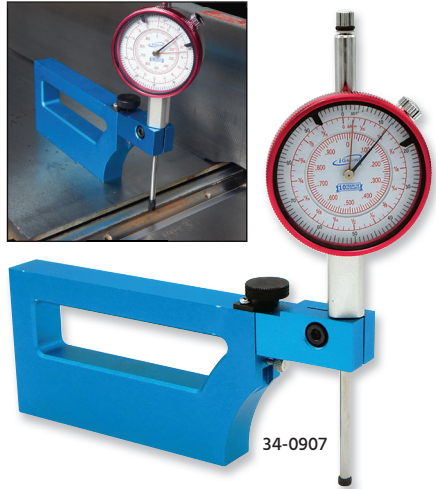
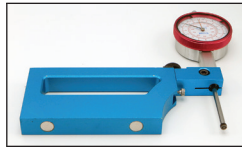
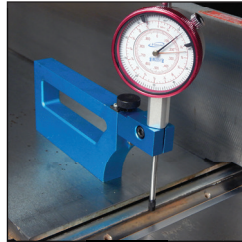
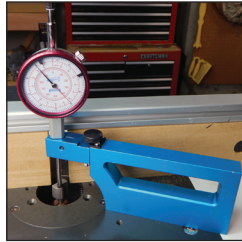
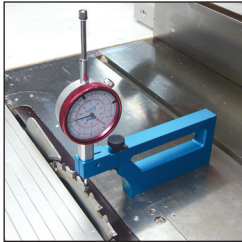

34-0907



PREMIUM BUILT

- Measuring Range: 0 - 2"
- Dial indicator rotates 360°
- Fine adjustment knob
- Solid aluminum body
- Strong magnet base
- Ball, Flat and extended tip anvils included

DIAL INDICATOR

- Range: 0 - 2"
- Stem dia.: $\frac{3}{8}$ "
- Thread size: #4-48
- 3-Way reading dial indicator:
 - 0.001" (outer dial)
 - $\frac{1}{64}$ " (middle)
 - 0.1 (inner)

Item # 34-0907

3-IN-1 DIGITAL MULTI GAUGE

MEASURES HORIZONTAL, VERTICAL & 90°

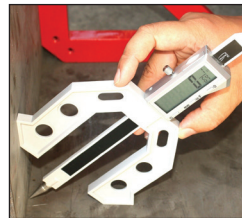
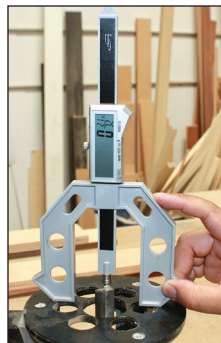
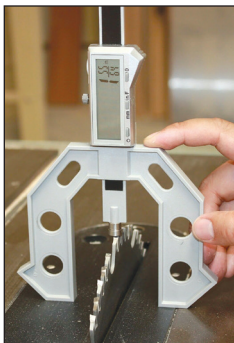

- Measuring Range: 0 - 6"/150 mm
- 0 - 3.10" Router depth
- 0 - 2.90" Slot depth

- Reading: 0.0005", 0.01 mm, $\frac{1}{64}$ "
- Accuracy: ± 0.001 " per inch
- Useful angle on frame: 70°, 80° & 90°
- Flat and point anvils included.
- Heavy-duty polycarbonate frame.
- Battery: 3V CR2032 included

Item # 35-0906

BENCH SQUARES & SETS

INCH AND METRIC

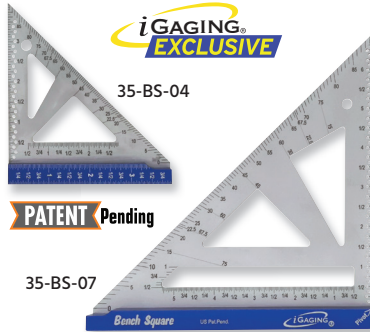
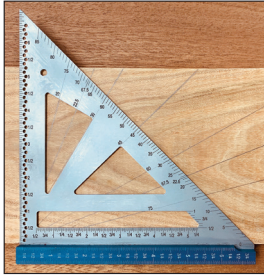

- Sizes:
 - 4" & 7" with 16th and 32nd scales
 - 100 & 175 mm with 1 mm graduations
- Scale accuracy: 0.0015"
- Squareness: 0.005"
- 0 - 90° markings in 1° angle graduations with 22.5° and 67.5°
- Center cutouts have a 15°, 22.5°, 30°, 45°, 60°, 67.5°, 75° angle markings
- Straight edge scale has drilled holes every $\frac{1}{8}$ "/2 mm
- 2 mm CNC stainless steel squares with a matte non-glare finish
- Aluminum base with blue anodized finish is $\frac{1}{2}$ "/12.5 mm tall and blades offset at $\frac{1}{4}$ "/5 mm and $\frac{3}{8}$ "/8 mm with ruler $\frac{1}{32}$ "/1 mm graduations markings on $\frac{1}{4}$ "/5 mm side and a pivot point on the other
- Precision laser engraving on both sides of square
- Sets include a mechanical pencil and lead refills
- Supplied in protective case.

INCH

Item #	Description
35-BS-04	4" Bench Square
35-BS-07	7" Bench Square
35-BS-47	4" & 7" Bench Square Set

METRIC

Item #	Description
35-BS-04-M	100 mm Bench Square
35-BS-07-M	150 mm Bench Square
35-BS-47-M	100 & 150 mm Bench Square Set

LAYOUT SQUARES & SET

- 6" square has a 7" outside scale, 6" inside scale plus a 3" scale on the bottom & $\frac{1}{4}$ " on the ends
- 12" square has a 13" outside scale, 12" inside scale plus a 5" scale on the bottom & $1\frac{3}{8}$ " on the ends
- Outer rule is 16ths scale and has left to right and centering rule with small drilled holes every $\frac{1}{16}$ "
- Inner rule is 32nds scale and has left to right rule with small drilled holes every $\frac{1}{32}$ "
- Angle markings and drilled holes in the center from 5° to 60° in 5° increments plus a 22.5°
- Aluminum base with blue anodized finish is $\frac{1}{2}$ " tall and blades offset at $\frac{1}{4}$ " and $\frac{3}{8}$ " and a 45° cut out
- Squareness: 0.0002" per inch
- Laser engraving on both sides of 2 mm blades
- Set includes a mechanical pencil and lead refills
- Supplied in protective case



Item #	Description
36-LS-07	7" Layout Square
36-LS-12	12" Layout Square
36-LS-712	7" & 12" Layout Square Set
36-LS-712M	175 & 325 mm Layout Square Set

RIGHT ON PRECISION SETUP BLOCK SETS

INCH & METRIC



36-SB-15



36-SB-8

- 8 Pc. Inch set includes: $\frac{1}{16}$ " , $\frac{3}{32}$ " , $\frac{1}{8}$ " , $\frac{3}{16}$ " , $\frac{1}{4}$ " , $\frac{3}{8}$ " , $\frac{1}{2}$ " , $\frac{7}{8}$ "
- 15 Pc. Inch set includes: $\frac{1}{16}$ " , $\frac{3}{32}$ " , $\frac{1}{8}$ " , $\frac{5}{32}$ " , $\frac{3}{16}$ " , $\frac{7}{32}$ " , $\frac{1}{4}$ " , $\frac{5}{16}$ " , $\frac{3}{8}$ " , $\frac{7}{16}$ " , $\frac{15}{32}$ " , $\frac{1}{2}$ " , $\frac{23}{32}$ " , $\frac{3}{4}$ " , $1 \times 2 \times 3$ "
- 15 Pc. Metric set includes: 1.5, 2, 3, 4, 5, 6, 6.5, 7, 8, 10, 12.5, 16, 19, 20, 25 x 50 x 75 mm
- Block thickness accuracy: 0.001"/0.025 mm
- Block size: 3" long x $\frac{1}{2}$ " thick
- Engraved scales on one side and bottom of the 1" x 2" x 3" bar in $\frac{1}{32}$ " increments
- Solid aluminum with blue anodized finish
- Supplied in protective case

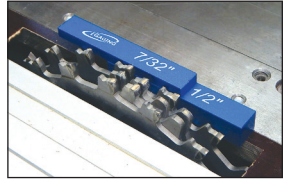

Item #	Description
36-SB-8	8 Pc. Inch - Right On Precision Setup Block Set
36-SB-15	15 Pc. Inch - Right On Precision Setup Block Set
36-SB15M	15 Pc. Metric - Right On Precision Setup Block Set

1-2-3 & 2-4-6 BLOCK SETS

MATCHED PAIRS

- Precision ground and case hardened on all six sides
- Hardness: 56 - 60 RC
- Parallelism: 0.0002"

1-2-3 BLOCK SET:

- Squareness on all sides within 0.0001"
- Matched accuracy of 0.0002"
- Accuracy of 0.0003" per inch
- 23 holes: 5 tapped ($\frac{7}{8}$ " - 16), 18 untapped

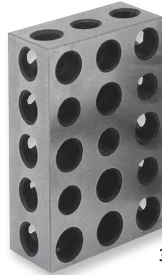

34-123

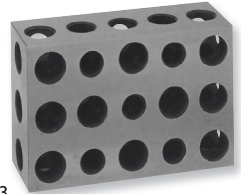

2-4-6 BLOCK SET:

- Squareness on all sides within 0.0003"
- Surface finish 6 to 16 micro inches
- Matched accuracy of 0.0002"
- Accuracy of 0.0003" per inch
- 23 holes: 5 tapped ($\frac{5}{8}$ " - 11), 18 untapped
- Supplied in protective case



34-246



Item #	Description
34-123	1-2-3 Block Set
34-246	2-4-6 Block Set w/ Protective Case

IP54 3-IN-1 DIGITAL MARKING GAUGE

MARKING/MORTISE GAUGE & DIVIDER

- IP54 protective rating:
Moisture and dust resistance
- Measuring range: 0 - 6"
- Compass range: 0 - 8" radius
- Divider range: 0 - 16" diameter
- Accuracy: 0.001"
- Repeatability: 0.0005"
- Reading: 0.0005"/0.01 mm/1/128"
- Large LCD display
- Hardened alloy pin
- Precise marking on steel & wood surfaces
- Battery: 3V CR2032 included

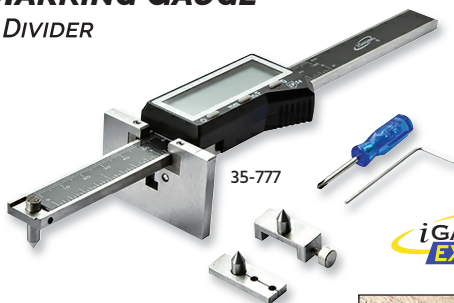

Item # 35-777

PATENTED

IP54 3-IN-1 DIGITAL MARKING WHEEL

MARKING, HEIGHT & DEPTH GAUGE

- IP54 protective rating:
Moisture and dust resistance
- Measuring range: 0 - 6"
- Accuracy: 0.001"
- Repeatability: 0.0005"
- Reading: 0.0005"/0.01 mm/1/64"
- Large LCD display
- Hardened alloy marking wheel
- Beveled wheel cutter pulls gauge against stock
- Battery: 3V CR2032 included



PATENTED

Item # 35-780

IP54 DIGITAL PLANTER GAUGE

- IP54 protective rating:
Moisture and dust resistance
- Measuring range: 0 - 5/32"
- Accuracy: 0.001"
- Reading: 0.0005"/0.01 mm/1/128"
- Large LCD display
- Magnetic base holds tight to the plane
- Battery: 3V CR2032 included



PATENTED



35-0908

PREMIUM WHEEL MARKING GAUGES

MICRO ADJUSTABLE & MORTISE



- 0 - 6"/150mm laser etched graduated scales in 32nds/1 mm increments
- Solid brass head and knurled clamp screw on a 8" steel shaft
- Hardened alloy steel marking blade with a bevel edge
- Can be used as a depth gauge
- Micro Adjustable on item #'s 34-711 and 34-710
- Mortise Gauges include: 2 mortise blades, support ring and screwdriver

Item #	Description
34-707	Wheel Marking Gauge
34-708	Mortise Wheel Marking Gauge
34-710	Micro Adjustable Wheel Marking Gauge
34-711	Micro Adjustable Mortise Wheel Marking Gauge
34-707-W	Repl. Wheel Cutter for 34-707 & 34-710
34-708-W	Repl. Wheel Cutter for 34-708 & 34-711

PATENT Pending



DELUXE EBONY WOOD 2-IN-1 MARKING & MORTISE GAUGE

- Deluxe Ebony wood body
- Brass rubbing strips and wear plug
- Mortise gauge measures: 8" long, beam is 3/4" square
- Head measures 2 1/4" x 2 1/2" x 1 1/8"
- Hardened alloy steel pins
- Pins adjust from 1/4" - 2"

Item # 34-777



DELUXE EBONY WOOD 9" SLIDING BEVEL GAUGE

- Deluxe Ebony wood body
- Brass lock and finished ends
- 9" stainless steel blade
- 6" ebony handle

Item # 34-709

**QUALITY
BUILT**



DELUXE EBONY WOOD PREMIUM TRI SQUARES

- Deluxe Ebony wood body
- Triple-pinned blue tint stainless steel blade for strong hold and corrosion resistance
- 1/8" thick brass facing for durability and stability

Item #	Description
34-T04	4" Tri Square
34-T06	6" Tri Square
34-T08	8" Tri Square

10X - 200X DIGITAL MEASURING MICROSCOPE

- Magnification: 10 – 200X
- Focusing: 8 – 300 mm
- LED adjustable light
- Android device, Windows & Mac PC, software and user manual included on Flash drive
- View modes: measuring software, camera, video & live stream
- USB port to recharge battery and transmit pictures & videos.
- Can be connected up to 3 devices
- WiFi IEEE 802.11 transmitting up 5m
- Stand with Microscope holder optional

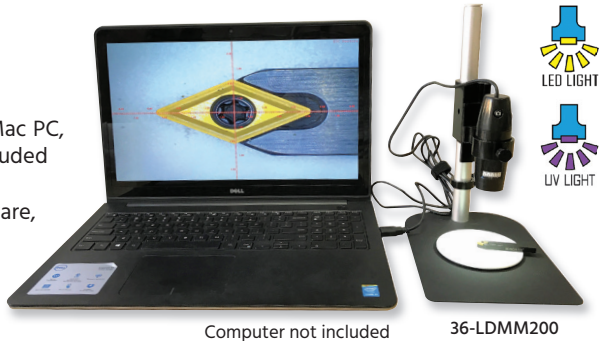

Computer not included

36-LDMM200



Item #	36-LDMM200	36-LDMM201	36-LDMM202
Magnification:	10X - 200X @ 17" monitor full screen		
Optical Format:	1/3" CMOS Sensor 4:3	1/4" CMOS Sensor 4:3	
Field of View (min.):	1.9 mm x 2.5 mm @ 17 mm working distance (200X)	1.9 mm x 1.5 mm @ 17 mm working distance (200X)	
Field of View (max.):	75 mm x 100 mm @ 300 mm working distance (10X)	82 mm x 60 mm @ 300 mm working distance (10X)	
Video Capture			
Resolution:	1600 x 1200, 1280 x 1960, 640 x 480	1280x1024, 640x480	
Image Color:	24 bit RGB or YUV or MJPG	YUV or MJPG	
Image Sensor:	2.0 mega pixels	1.3 mega pixels	
Light Source:	LED	LED	LED & UV
Dimensions:	122 mm L x 36 mm D	142 mm L x 36 mm D	
Output:	USB	USB & WiFi	
Microscope Stand	No	Yes	

6X - 39.4X HDMI DIGITAL MEASURING MICROSCOPES

- Built-in multi-function image processing software
- Rear focus mode extends working distance
- Independent control of two ring lights, free combination adjustment

HDMI DIGITAL MICROSCOPE WITH 12.5" MONITOR - 35-CE2310T-A

- 12.5 inch 1080P HD color display, live image is displayed instantly upon startup
- Monitor angle can be finely adjusted, forward tilt $\leq 135^\circ$, back tilt is $\leq 20^\circ$
- Independent control of two ring lights, free combination adjustment
- Powered directly from display.

NEW



35-CE2310T-A

HDMI DIGITAL MICROSCOPE - 35-CE2310T-C*

- 360° universal hinge bracket design, supports arbitrary hovering, flexible and easy to use
- Compact and light weight



35-CE2310T-C*
*Special Order

Item #	35-CE2310T-A	35-CE2310T-C*
Image Sensor:	SONY CMOS IMX291	
Max. Resolution:	1920 x 1080 (2,073,600 pixels)	
Sensor:	1/2.8" (6.058 mm (H) x 4.418 mm (V),	
Pixel Size:	2.9 μm x 2.9 μm	
Dynamic Range:	128 dB	
SNR:	30 dB	
Spectral Response:	380 ~ 650 nm	
Exposure:	Real-time auto, single auto, manual adjustment	
White Balance:	Real-time automatic, single automatic, manual RGB adjustment	
Picture HDMI Resolution:	Auto-adaptive display, 1920 x 1080P60	
Picture HDMI:	1920 x 1080	
Format:	JPG	
Video Resolution:	1920 x 1080P60, 1920 x 1080P30, 1280 x 720P120, 1280 x 720P60	
Format:	JPG	
Record Path:	TF card (up to 128G)	
Power Supply:	DC 12V Ax3 cable adapter	DC 5V 900mA, by USB port
Working Distance:	44 - 200 mm	44 - 230 mm
Field of Depth:	0.8 - 7 mm	0.8 - 6.5 mm
Observation Range (mm):	7 x 4 mm (@ highest magnification 39.4X) to 45.7 x 25.8 mm (@ lowest magnification 6X)	

*Special order

LED MEASURING MICROSCOPES

- Extreme high resolution and distortion free
- Lighted by super bright 3 LED
Can be used in total darkness
- Reticle precision: 0.0005"/0.01 mm
- Max measuring: 0.04"/1.2 mm
- Reticle has fine 90° crosshairs in center
- Adjustable focal point for 2 1/2"
- Stand included
- Supplied in protective case



36-LM100



**iGAGING®
EXCLUSIVE**

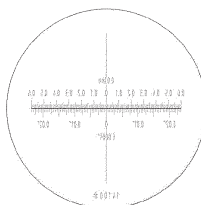

Item #	Magnification	Accuracy
36-LM20X	20X	0.00015"/0.003 mm
36-LM40X	40X	0.00015"/0.003 mm
36-LM60X	60X	0.00015"/0.004 mm
36-LM100X	100X	0.00015"/0.004 mm

LED 10X OPTICAL LOUPES W/RETICLES

DISTORTION FREE LENSES WITH LENGTH, DIAMETER, RADII, ANGLES, PITCH & THICKNESS



36-LED10

**iGAGING®
EXCLUSIVE**



36-LED10-9

- Size: 2" H x 1 3/4"
- Viewing area: 1 1/4"
- Reticle dia.: 1 3/8"
- 8 bright LED
- Precision laser etched glass scales supplied in individual plastic cases
- ISO 9001 certified
- Battery: AG9 included

10X OPTICAL LOUPE

- Reticle: #2
- Supplied in leather case

10X OPTICAL LOUPE W/9 RETICLES

- Reticles: #1, #2, #3, #4, #6, #7, #8, #10
- Supplied in protective case

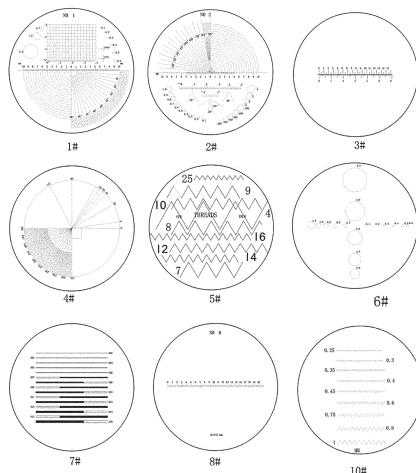

Item #	Description
36-LED10	10X Optical Loupe w/#2 Reticle
36-LED10-9	10X Optical Loupe w/9 Reticles

2-IN-1 JEWELRY LOUPE MAGNIFIER

10X - 18 MM & 15X - 12MM LENSES

- Distortion Free with fine resolution
- Stainless steel finish
- Supplied in leather case

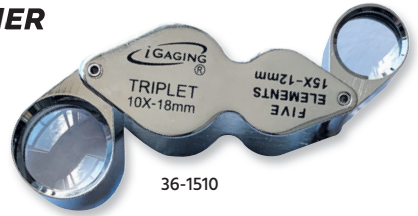

Item # 36-1510



36-LUV20

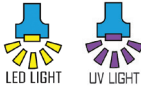

LED & UV

TRIplet MAGNIFIER LOUPES

10X - 21 MM & 20X - 21 MM

- Distortion free lenses
- 6 LED white lights
- 7 UV lights - extra light in base
- ON/OFF switch
- ISO 9001 certified
- Protective metal casing
- Battery: LR927 included
- Supplied in leather case

Item # Description

36-LUV10	10X Lens w/LED & UV Lights
36-LUV20	20X Lens w/LED & UV Lights

Pocket SCOPE MAGNIFIERS

20X & 40X

- Distortion free
- Size: 4.78" L x 0.44" Dia.
- Glass lens protected by anodized aluminum body
- Pocket clip included
- Weight: 0.6 oz.
- Battery: AAA (not included)

20X SCOPE MAGNIFIER

- 0 - 0.18" scale markings with 0.002" graduations

40X SCOPE MAGNIFIER

- 0 - 0.07" scale markings with 0.001" graduations

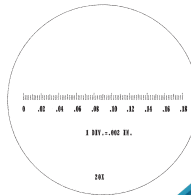

36-PM20



36-PM40

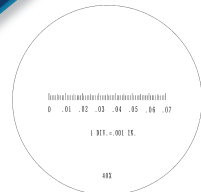

Item # Power

36-PM20	20X Pocket Scope Magnifier
36-PM40	40X Pocket Scope Magnifier



36-1009

10X OPTICAL LOUPES w/9 RETICLES

*DISTORTION FREE LENSES WITH LENGTH,
DIAMETER, RADII, ANGLES, PITCH & THICKNESS*

- Reticle dia.: 1"
- Reticles: #1, #2, #3, #4, #6, #7, #8, #10
- Precision laser etched glass scales supplied in individual plastic cases
- Supplied in protective case

Item # 36-1009

LED WORK LIGHTS WITH MAGNETIC BASE MINI FLEX AND UNIVERSAL ARMS

- High Intensity 500 lumens LED light
- 3 power modes: High beam, low beam and emergency flash
- Fish eye lens with 1 x 2000 zoom
- Magnetic pull: 40 lbs.
- Chrome steel mounting plate and hardware included
- Batteries: 4 x AAA included



LED LIGHT



36-1460Z



MAGNETIC
BASE

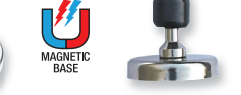

36-1480Z



Item #	Description
36-1460Z	7" Universal Arm Work Light w/Magnetic Base
36-1480Z	9" Mini Flex Arm Work Light w/Magnetic Base

LED MAGNIFIER & MAGNETIC BASE & CENTER RULE ANGLE GAUGE SET

- 4X optical magnifier
- 8X spot viewer
- 12 ultra bright LED lights
- 10" metal flexible arm
- Rare earth magnetic base
- 8" x 3" center rule and angle gauge base
- Batteries: 3 AAA included



MAGNETIC
BASE

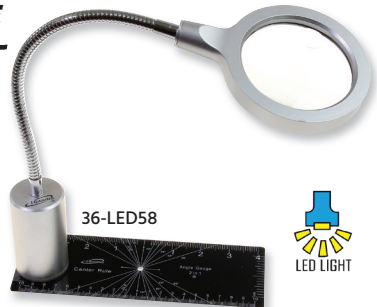

36-LED58



LED LIGHT

CENTER RULE & ANGLE GAUGE (34-C08)

- Measures inch, metric and angles
- Engraved markings center rules in 16ths (top) and 1 mm (bottom), sides are in 8ths and 32nds
- Angle scales from 0° to 60° in 15° increments with a 22.5° angle
- Center marking hole
- Made of black painted hardened steel

Item # 36-LED58



IP54 DIGITAL EZ BRAKE ROTOR GAUGE

MEASURE ROTORS WITHOUT REMOVING THE WHEEL



- IP54 protective rating: Moisture and dust resistance
- Range: 0 - 3.2"/80 mm
- Accuracy: $\pm 0.001"/0.02$ mm
- Resolution: $0.0005"/0.01$ mm/ $1/64"$
- Repeatability: $0.001"/0.01$ mm
- X-Large LCD display
- On/Off button

- Hold button
- Jaw depth: 1.10"
- Hardened stainless steel body
- Battery: 3V CR2032 included
- Supplied in protective case



Item # 100-048-i

iGAGING®
EXCLUSIVE

IP40 DIGITAL DISC BRAKE ROTOR MICROMETERS

- IP40 protective rating: Solid objects over 1 mm
- Easy to read LCD display
- Accuracy: $0.0015"/0.003$ mm
- Resolution: $0.0005"/0.001$ mm
- On/Off button
- Ratchet thimble
- 1" measuring standard included
- Carbide tipped measuring faces
- Battery: 3V CR2032 included
- Supplied in protective case



iGAGING®
EXCLUSIVE

IP40

Item # Range

35-230e 0.3" - 1.3"/7 - 32 mm

35-040-317 0.7" - 1.7"/18 - 43 mm

35-230e

DIGITAL ROTOR GAUGE

- Range: 0 - 3"/75 mm
- Accuracy: $0.001"/0.02$ mm
- Resolution: $0.0005"/0.01$ mm/ $1/64"$
- Easy to read LCD display
- On/Off button
- ABS and Zero button
- Jaw depth: 3.5"
- Carbide tipped measuring faces
- Battery: 3V CR2032 included
- Supplied in protective case



100-040

Item # 100-040



100-048

IP54 DIGITAL SPEED DRUM GAUGE

- IP54 protective rating: Moisture and dust resistance
 - Range: 2" - 18"/50 - 457 mm
 - Accuracy: 0.005"/0.13 mm
 - Resolution: 0.0005"/0.01 mm / 1/64"
 - Large LCD display
 - On/Off button
 - Hold button
 - Hardened steel conical contact points
 - Carriage lock screw
 - Alloy measuring jaws
 - Battery: 3V CR2032 included
 - Supplied in protective case
- Item #** 100-068

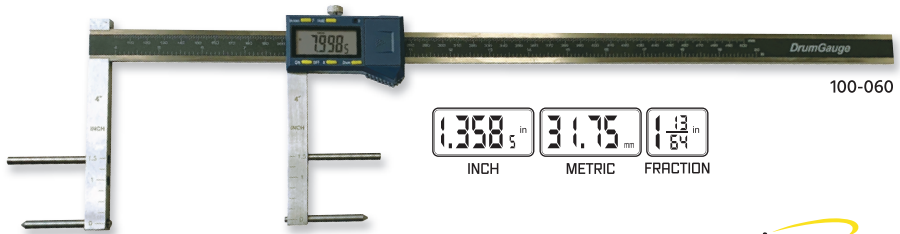

100-060

IP54 DIGITAL BRAKE DRUM GAUGE

- IP54 protective rating: Moisture and dust resistance
 - Range: 4" - 20"/100 - 500 mm
 - Accuracy: ±0.003"/0.07 mm
 - Resolution: 0.0005"/0.01 mm / 1/64"
 - Repeatability: 0.002"/0.05 mm
 - Large LCD display
 - 4" drum preset button
 - 1" & 1.5" depth preset pins
 - On/Off button
 - Hold button
 - Alloy jaws
 - Battery: 3V CR2032 included
 - Supplied in protective case
- Item #** 100-060



DIGITAL TIRE TREAD DEPTH GAUGE

- Range: 0 - 1"/25 mm
 - Accuracy: ±0.0015"
 - Resolution: 0.0005"/0.01 mm / 1/32"
 - Spring loaded movement
 - Large LCD display
 - On/Off button
 - Hold reading function
 - Rod dia.: 3/32"
 - Base: 2" L x 1/4" W
 - Battery: 3V CR2032 included
- Item #** 35-32ND



35-32ND



FLEX ARM, ANYSURFACE BASE & LOCKING PLIERS DISC & ROTOR/BALL JOINT SETS

FOR INSPECTION OF BRAKE ROTOR RUNOUT
AND BALL JOINT WEAR



34-103



35-103



35-108

FLEX ARM

- 12" flex arm rotates 360°
- Indicator mount with 1/2" max. capacity
- Accepts all AGD indicators
- Cam lever locks arm in any position

DIAL INDICATOR (400-001)

- Range: 0 - 1"
- Reading: 0 - 100
- Graduation: 0.001"
- Accuracy: 0.001"

DIGITAL INDICATOR (35-128)

- Range: 0 - 1"
- Reading: 0.0005"/0.01 mm/1/128"
- Accuracy: 0.001"

LOCKING PLIERS

- 7" curved jaw
- Jaw capacity: 1 1/4"

ANYSURFACE MAGNETIC BASE

- 70 steel segments independently align and attach themselves firmly to uneven surfaces
- Single cam lock lever securely locks segments in adapted form
- Magnetic pull: 125 lbs.
- Dimension: 2 1/2" L x 2" W x 1 3/4" H
- Sets supplied in protective case



34-109



35-109

Item #	Indicator	Description
34-103	Dial (400-001)	Locking Pliers
34-108	Dial (400-001)	AnySurface & Locking Pliers
34-109	Dial (400-001)	AnySurface Magnetic Base
35-103	Digital (35-128)	Locking Pliers
35-108	Digital (35-128)	AnySurface & Locking Pliers
35-109	Digital (35-128)	AnySurface Magnetic Base
34-103-N	—	Locking Pliers
34-108-N	—	AnySurface & Locking Pliers
34-109-N	—	AnySurface Magnetic Base

IP65 DIAL INDICATOR, FLEX ARM & MAGNETIC BASE DISC & ROTOR/BALL JOINT SETS

FOR INSPECTION OF BRAKE ROTOR RUNOUT AND BALL JOINT WEAR

DIAL INDICATORS

(400-065-01 & 400-065-05)

- IP65 protective rating:
Coolants, grit and dust proof
- Range: 0 - 1"

FINE ADJUSTMENT ARM



- 12" reach
- Fine adjustment knob
- Accepts indicators with $\frac{3}{8}$ " / 8 mm stems, lug backs, and dovetails.

MAGNETIC BASE

- V-Groove base allows mounting on cylindrical surfaces
- On/Off switch
- Magnetic pull: 176 lbs.
- Base size: $2\frac{1}{2}$ " L x 2" W x $2\frac{1}{8}$ " H



34-107

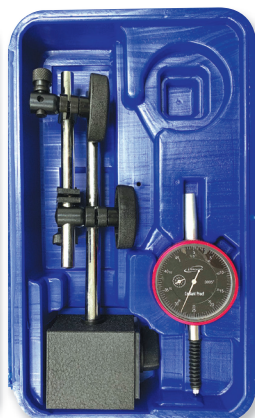

34-107-5

Item #	iP65 Indicator	Reading	Graduation
34-107	Dial (400-065-01)	0 - 100	0.001"
34-107-5	Dial (400-065-05)	0 - 50	0.0005"



100-108

VERNIER DEPTH GAUGES

- Easy to read
- Made of hardened stainless steel
- Dull chrome finish

Item #	Range
100-106	0 - 150 mm
100-107	0 - 200 mm
100-108	0 - 300 mm

QUALITY ANGLE PLATES

FOR QUICK AND ACCURATE ANGLE SET UP

- 2 piece set
- Accuracy: ± 20 seconds
- Thickness: $\frac{1}{4}$ "
- 1 pc: 4" x $3\frac{12}{32}$ " x 2" with 30°, 60° & 90° angles
- 1 pc: 3" x 3" x $4\frac{3}{8}$ " with 45°, 45° & 90° angles
- Four $\frac{11}{32}$ " holes for easy mounting
- Hardened and precision ground
- Supplied in protective case

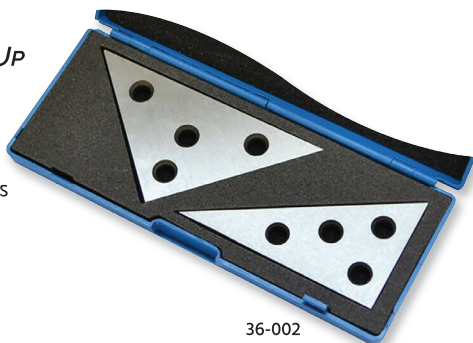

36-002

Item # 36-002

1 - 30° PRECISION ANGLE BLOCK SET

FOR QUICK AND ACCURATE ANGLE SET UP

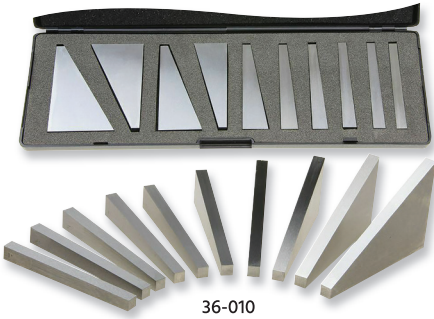

- 10 piece set
- Accuracy: $\pm 0.006^\circ$
- Set includes: 1°, 2°, 3°, 4°, 5°, 10°, 15°, 20°, 25°, 30°
- Angles etched on blocks
- Size: 3" L x $\frac{1}{4}$ " Thick
- Hardened and precision ground
- Supplied in protective case

Item # 36-010

NEEDLE FILE SET

SWISS PATTERN

- 12 piece set
- Includes: Barrette, Crossing, Equaling, Half Round, Knife, Marking, Round, Round Edge Joint, Slitting, Square, Three Square, Warding
- Length: 6"
- Cut: #2
- Hardened steel construction
- Supplied in storage pouch

Item # 36-126

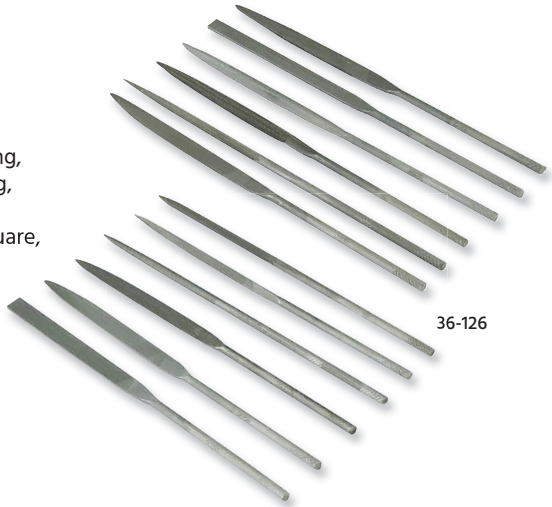

36-107

RIFFLER FILE SET

- 10 piece set
- Includes: riffler flat and triangle files
- Length of cut: $1\frac{9}{16}$ "
- Overall Length: $5\frac{1}{2}$ "
- Grit: 150
- Non-slip rubber grips
- Hardened steel construction
- Supplied in storage pouch

Item # 36-107

V-BLOCKS W/CLAMPS SET

MATCHED PAIR

- Set includes:
 - 2 each: 1½" L x 1½" W x 1¼" H (1" v-capacity)
 - 2 each: 2" L x 1½" W x 1½" H (1½" v-capacity)
 - 4 clamps
- Two 90° V's on each V-Block, clamps included
- Made of chrome steel, hardened and ground to 0.0005"
- Supplied in protective case

iGAGING®
EXCLUSIVE



36-VB8

Item # 36-VB8



36-S302-i

AUTOMATIC CENTER PUNCH

- Length: 6"
- Point size: ¼"
- Spring loaded movement
- Hardened steel construction
- No hammer required
- Removable tip for easy replacement

Item # 36-S302-i



36-628

TRANSFER PUNCH SET

- 28 piece set
- Size range: 3/32" to 1/2" x 64th, plus 17/32"
- Length: 4 7/8"
- 0.0025" undersized for easy use
- Heat treated tempered tool steel
- Black oxide finish
- Supplied in fitted indexed stand

Item # 36-628



34-604

SMALL HOLE GAGES

FULL BALL TYPE

- Rigid handle for easy grip and adjustment
- Satin chrome finish
- Supplied in storage pouch

Item #	Range	Meas. Depth
34-604-1	0.125 - 0.200"	0.880"
34-604-2	0.200 - 0.300"	1.200"
34-604-3	0.300 - 0.400"	1.600"
34-604-4	0.400 - 0.500"	1.600"
34-604	Set of above 4 Gages	

TELESCOPING GAGES



34-606

- Range: $\frac{5}{16}$ " - 6"
- Uniform contact pressure
- Rigid handle for easy grip and adjustment
- Satin chrome finish
- Supplied in storage pouch

Item #	Range	Length
34-606-1	$\frac{5}{16}$ " - $\frac{1}{2}$ "	4.2"
34-606-2	$\frac{1}{2}$ " - $\frac{3}{4}$ "	4.2"
34-606-3	$\frac{3}{4}$ " - $1\frac{1}{4}$ "	4.2"
34-606-4	$1\frac{1}{4}$ " - $2\frac{1}{8}$ "	5.85"
34-606-5	$2\frac{1}{8}$ " - $3\frac{1}{2}$ "	5.85"
34-606-6	$3\frac{1}{2}$ " - 6"	5.85"
34-606	Set of above 6 Gages	

THICKNESS FEELER GAGE

DUAL READING - INCH/METRIC

- 32 blades
- Length: $3\frac{7}{8}$ "
- Range: 0.0015" - 0.035"/0.04 - 0.88 mm
- Sizes: (Inch/Metric)

0.0015"/0.04 mm	0.010"/0.25 mm	0.021"/0.53 mm
0.002"/0.05 mm	0.011"/0.28 mm	0.022"/0.55 mm
0.0025"/0.06 mm	0.012"/0.30 mm	0.023"/0.58 mm
0.003"/0.08 mm	0.013"/0.33 mm	0.024"/0.60 mm
0.004"/0.10 mm	0.014"/0.35 mm	0.025"/0.63 mm
0.005"/0.13 mm	0.015"/0.38 mm	0.026"/0.65 mm
0.006"/0.15 mm	0.016"/0.40 mm	0.028"/0.70 mm
0.007"/0.18 mm	0.017"/0.43 mm	0.030"/0.75 mm
0.008"/0.20 mm	0.018"/0.45 mm	0.032"/0.80 mm
0.009"/0.23 mm	0.019"/0.48 mm	0.035"/0.88 mm
0.010"/0.25 mm	0.020"/0.50 mm	
- Each blade is marked with thickness
- 65 manganese steel
- Satin chrome finish



36-632-EM

Item # 36-632-EM

DISCLAIMER: Manufacturer supplied product information and specification. IPIC will make further notifications if information needs revision or correction on www.iGAGING.com. Please check with iGAGING for most current information. This booklet is informational only. By viewing this booklet, you waive the right to hold IPIC/iGAGING responsible for its content. Our terms, conditions, pricing and policies are subject to change without notice at anytime. Visit www.iGAGING.com for the current version.

Catalog Design: By Jessica Zimpel in California. LINKEDIN www.linkedin.com/in/jessica-zimpel-3a537577

Credit: Copyright work from Yanchen and William Zhang with information input from product source. Special thanks to Emily Ye, Iris Tang, Kevin Zhang, Mason Zhang, and Sean League. Special thanks to all iGAGING employees and associates for your hard work and dedication.

Warning: Products identified herein maybe known chemicals to the Sate of California to cause cancer and/or birth defects or other reproductive harm. For more information go to www.P65Warnings.ca.gov.

NEARSTAR SOLAR FINDER

- Find the sun with ease with the Nearstar Solar Finder.
- Adjustable solar finder will fit any Vixen style dovetail finder bracket, found on most telescopes today
- Metal body with red or black anodized finish

Item # IDEA-NSSF



IDEA-NSSF



IDEA-1420CA

FINDER MOUNT CAMERA ADAPTER

- 1/4-20 Camera adapter for any finder mount
- Made from solid aluminum, this will turn any finder bracket into a camera mount
- Black anodized finish

Item # IDEA-1420CA

FINDER DOVETAIL BRACKET

- This is a Vixen Style Finder Dovetail Bracket for hot shoes on DSLR or older SLR cameras
- Black anodized finish

Item # IDEA-VFDDSLR



IDEA-VFDDSLR

ELECTRONIC FOCUS CAMERA MOUNT

- This universal DSLR or SLR camera mount will convert any lens to electronic focus. The motorized version can be controlled over Bluetooth.
- All metal construction

Item # IDEA-PP-M

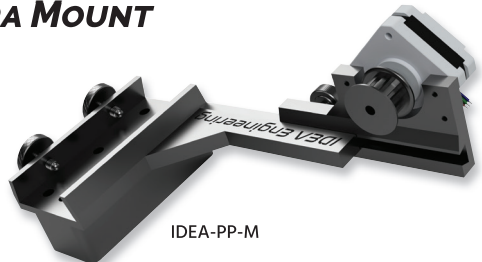

IDEA-PP-M

PRODUCT OF IDEA ENGINEERING - EXCLUSIVE DISTRIBUTION BY IDEA ENGINEERING
FOR MORE INFORMATION: WWW.IDEAENGINEERING.COM

Enjoy Accuracy



- Large selection of inventory
- Live customer services
- Fast worldwide express shipping

**COMING
SOON**

DIGITAL READOUT OF DRILL PRESS

MEASURES DRILLING DEPTH ACCURATELY

- Resolution: 0.0005"/0.01 mm/1/64"
- Accuracy: 0.0015"
- On/Off button
- Incremental function
- Auto shut off
- Stainless steel beam



PATENT Pending

35-600-4

Item #	Description
35-600-4	4" Digital Readout of Drill Press
35-600-6	6" Digital Readout of Drill Press



iGAGING is proud to provide real time ISO 17025 Calibration Certificate from certified laboratory locally in Orange County California USA. Please contact iGAGING for detail of this service.



25 YEARS OF EXCELLENCY



With innovative and high quality products, International Precision Instruments Corporation (IPIC) has been serving the precision measuring industry for more than 25 years. With two facilities in California (headquarters, design center, service center, and distribution center), and two manufacturing facilities and a field office in China, IPIC has the ability to communicate with customers and distribute products around the world with speed and accuracy. IPIC holds high standard with selective material, quality control, and customer service. At the same time, IPIC also focuses on bringing new and innovative products to the marketing year after year. With the trust of our customers, it is our pride to co-develop custom built gauges and parts to customer specifications. Our customers "Enjoy accuracy" when using our gauges and tools! With your continuing support, we proudly celebrate 25 years of hard work!

- Thank you! -

Into the Future...

iGAGING® is working closely with SpaceFab.US, pioneering the next generation space imaging technology and robotic space exploration.

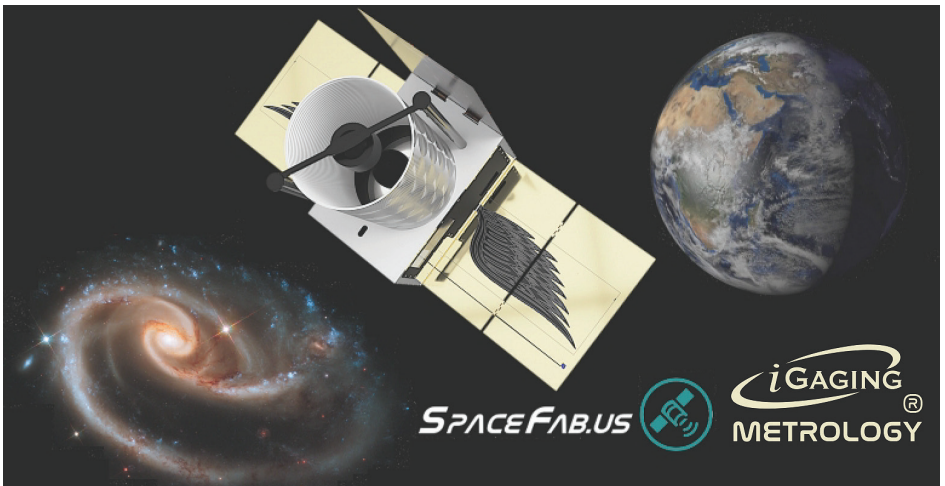

iGAGING

® SAN CLEMENTE - CALIFORNIA
www.iGAGING.com

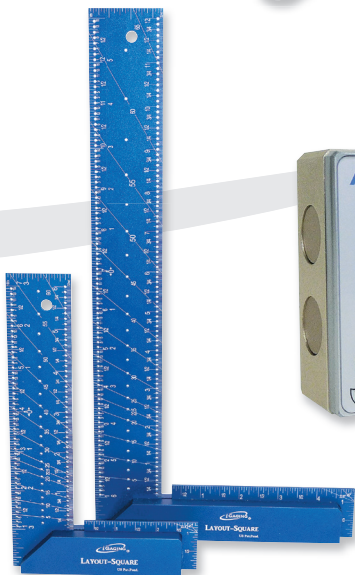

iGAGING.COM

COPYRIGHT © 2021 IPIC/iGAGING
PRINTED IN SAN CLEMENTE, CALIFORNIA, USA